

# NAZI UFO

## SECRETS AND BASES EXPOSED



BY  
DR. FRANK E. STRANGES

**DR. FRANK E. STRANCES**

---

**NAZI UFO SECRETS AND BASES EXPOSED**

**I.E.C. PUBLISHING COMPANY**

**CALIFORNIA**

Copyright by I.E.C. Publisher, Inc.  
1982 All rights reserved.

This edition is published by I.E.C.  
Publishing Company,

a division of International Evangelism  
Crusades, Inc.,

Post Office Box 5, Van Nuys, California 91408

IEC 1982 EDITION

ISBN 0-686-37108-9

Manufactured in the United States of America

# CONTENTS

INTRODUCTION	7
1 THE MYSTERY UNFOLDS	9
2 THE COANDA EFFECT	13
3 HITLER'S WILDEST WEAPON	17
4 THE FLYING DISCS AND THE V-7	21
5 THE U-209	23
6 THE RENO SIGHTING	27
EPILOGUE	30

# Design and Construction

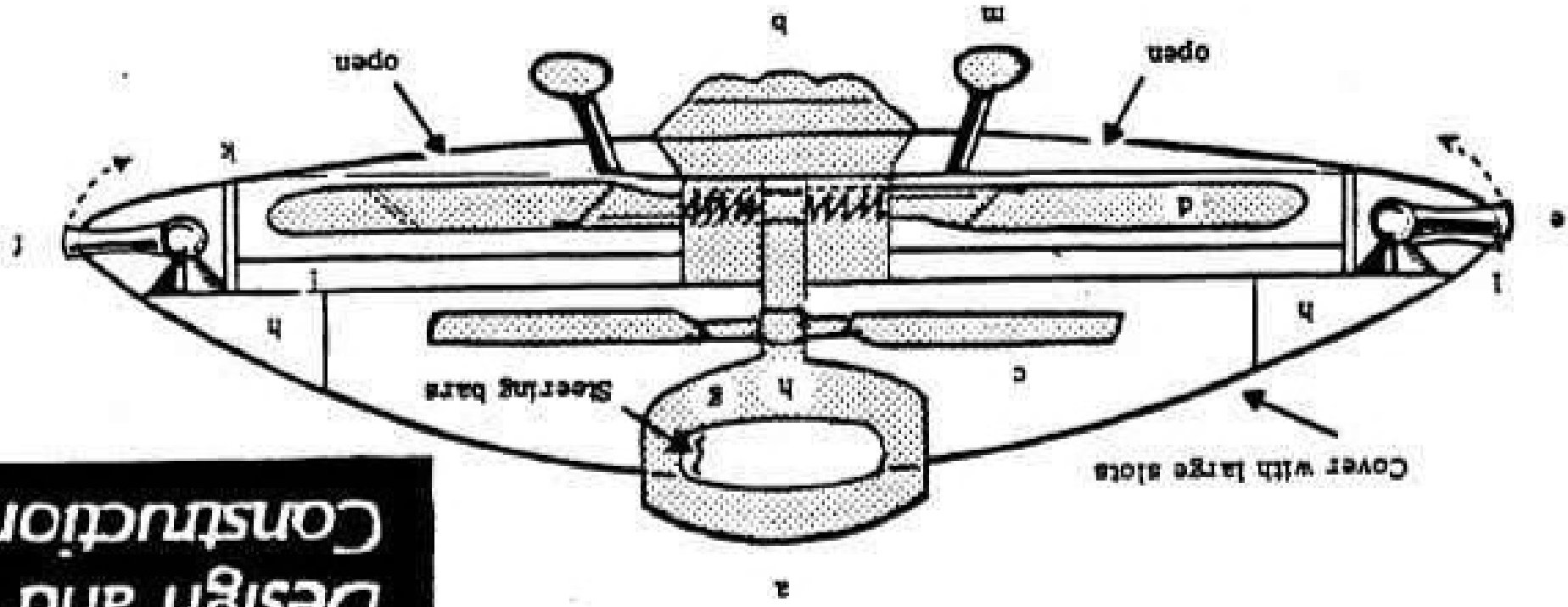

# INTRODUCTION

The UFO phenomena has for many years posed many problems. These problems have keenly disturbed individuals from every rank and file of society. It's a fact that UFO's have caused consternation in high places and in World Governments.

Any honest individual interested in the investigation of Unidentified Flying Objects must agree that regardless of what origin they represent, there is a fine line that must be drawn and recognized dividing fact from fiction.

The UFO phenomena can be separated into many factions. It must be readily understood that one sole answer to the UFO problem is not sufficient. It is important to rely on numerous facets of this unusual diamond in order to derive various possible explanations to the perplexing UFO question.

This book will explore one particular facet of the UFO diamond by zeroing in on the Nazi UFO secrets and bases. Sightings have been made of certain craft since 1945 that are said to be of German origin. This claim has been investigated thoroughly.

The following information will provide a crystal clear picture as to the import of this mystery.

The information in this book has been gathered from several sources. These include Herman Klass, Prof. Dr. Hermann Oberth (who was the teacher of the late Dr. Wernher von Braun), certain members of the German Secret Service, the Central Intelligence Agency files, the United States Air Force, and other Allied intelligent sources.

In the annals of UFO history, the "Nazi Saucers" were given four titles by the Allied Command: Smoky Saucers, Hitler's Wildest Dream, German Flying Discs, and Secret Flying Machines.

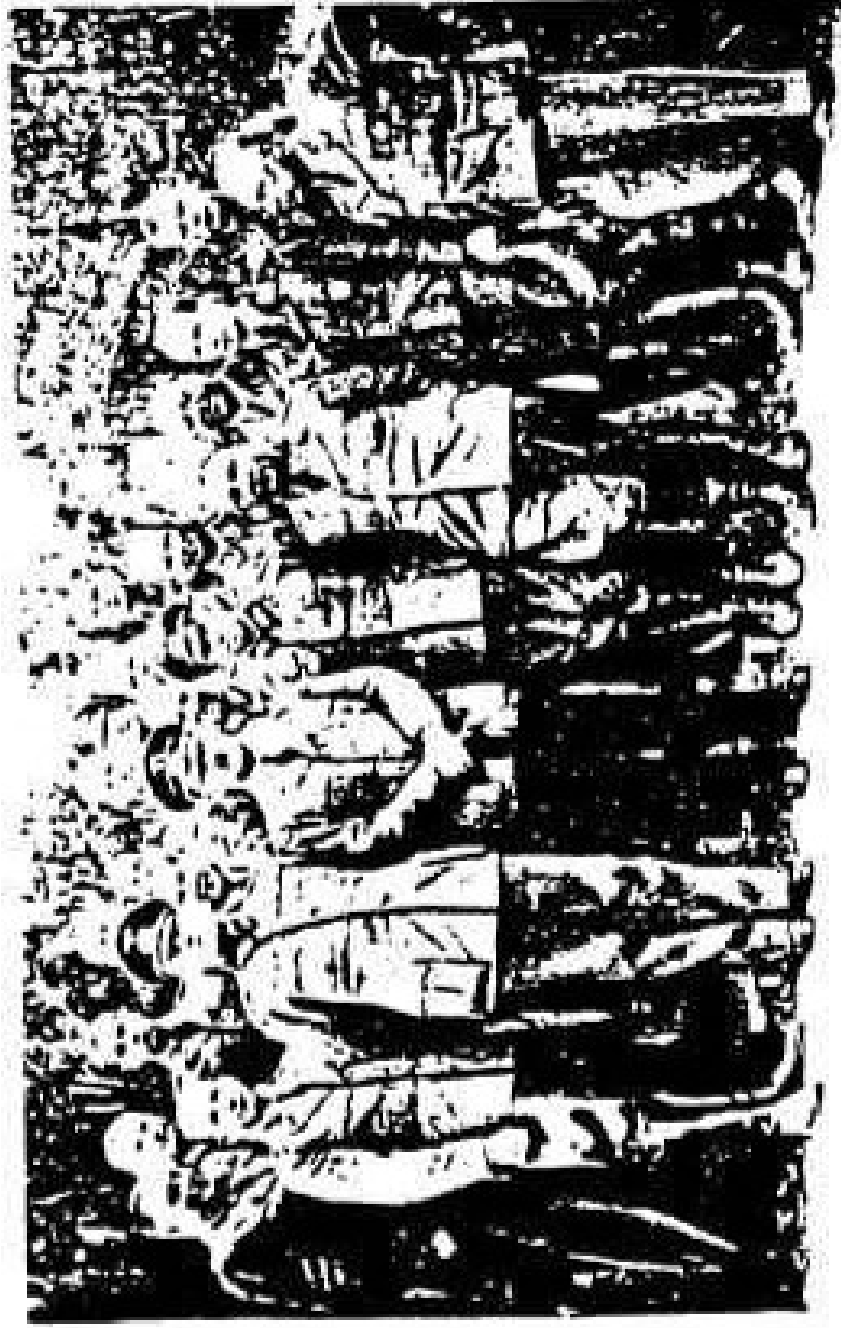

Hitler's military inner circle, May 1940. Front row, 1. to 5., Bückner (personal adjutant), Otto Dietrich (press chief), Keitel, Hitler, Jodl, Bormann, Below (Hitler's Luftwaffe adjutant), Hoffmann the photographer. Middle row, Bodenschatz (Göring's chief of staff), Schmundt, Wolf, Lt. Morell (Hitler's chief physician), Hans Georg Schulze (Hitler's ordnance officer, killed in battle and replaced by his brother Richard). Back row, Engel (Hitler's army adjutant), Dr. Brandt (Hitler's surgeon), Puttkamer, Lorenz (DNB), Walther Hewel (Foreign Office), unknown, Schaub (Hitler's personal adjutant), Wünsche. [www.fox.com](http://www.fox.com)

# 1

# THE MYSTERY UNFOLDS

The front page of a West German Newspaper, datelined August 20, 1966, shocked the whole of Europe and the United States: "FLIGHT DISCS IN MASS PRODUCTION!"

This report contained photographs, illustrations, factual events, actual names, dates, and precise places which stated in fact, that during the final fifteen days of the Third Reich, scientists and engineers vanished by the score from Germany, suddenly appearing in the city of Patagonia, South America.

Patagonia was the very first country in South America ever to report Flying Saucers in their skies.

During the years 1945-1947 three German Scientists who were also Engineers, along with one Italian Engineer, were involved in researching and developing a saucer-shaped craft.

## U.S. INTELLIGENCE REPORT

According to a Top-Secret United States Government Intelligence Report, Adolph Hitler called together a team of top-notch scientists



who were experts in the field of aerodynamics. Hitler asked them to devise advanced instrumentation that would turn the tide against the Allies.

Hitler was very concerned. The war outlook was not favorable for the Nazi Empire. He had to do something, fast! He had knowledge of certain Scientists working on a Top-Secret project involving a flying tube, a flying saucer, and a flying sphere. Hitler felt this team of Scientists: Habermohl, Helthe, Shrliever, and Alfonso Bellonzo, could perfect these devices to defy the forces of the Allies.

## SECRET DISCS

The crash program was underway. A saucer-shaped craft was erected in prototype form.

The idea behind this craft began in 1936. The United States was in the midst of a deep Depression and the population was gravely concerned. Breadlines were visible everywhere.

Meanwhile, in Europe, sports enthusiasts assembled by the thousands at the Olympic Stadium for the Summer Olympic Games. Adolph Hitler was the center of attraction.

During the opening ceremonies, all Nations participated in the special opening day parade.

The athletes competing in the Games marched proudly before the great crowd with their Nation's Flag held high. When they passed before the Fuhrer they all lowered their flags, except the United States of America.

Hitler gritted his teeth and turned his head the other direction. He had been advised by three Psychics that he would become the ruler of the World in the near future. This affront by the U.S. further resolved him to his ultimate goal of World Power.

During the Games, the Top Scientists of Germany were fascinated by the Discus throwers. Through this simplistic observation the idea

of a flying disc was brought into fruition.

## LIQUID FUEL RESEARCH

In 1923, a mathematical genius, Professor Hermann Oberth, wrote a classic book, "The Rocketry Into Interplanetary Space." (Prof. Oberth instructed Dr. Wernher von Braun, who eventually became the head of the American Space Program, headquartered in the State of Texas.)

"The Rocketry Into Interplanetary Space" was an important writing. Prof. Oberth wrote that, "Individuals of intelligent nature could have originated from other planets."

This book pioneered liquid fuel research for the German Empire. On March 14, 1931, Germany fired its first successful liquid fuel Rocket. It was the champion of the Rocket Missile System at that time. In 1932, the idea was sold as a complete package to the German Government.

General Walter W. Dornberger, head of the German Army, introduced the Scientists involved in this project to the heads of the German Government, for the sole purpose of obtaining their approval for further research.

Gen. Dornberger received forty million dollars for the development of a new long range Rocket at Peenemunde Island. The Peenemunde project proved significant in the evolution of Rockets and Missiles into German Flying Saucers.

It is interesting to observe that Governments as well as Corporations, usually succeed in achieving their goals when finances are made readily available. History provides sufficient evidence of this fact.

When Scientists can work unhampered by financial lack the results speak for themselves.

Last Proto Type 1943/45

Schriever - Habermohl Flying Disc

(NOTE: Hand drawn from Hermann Klaus original, by Carl F. Mayer. Not to scale.)

*Pilot Room - 2 Pilots reclining*

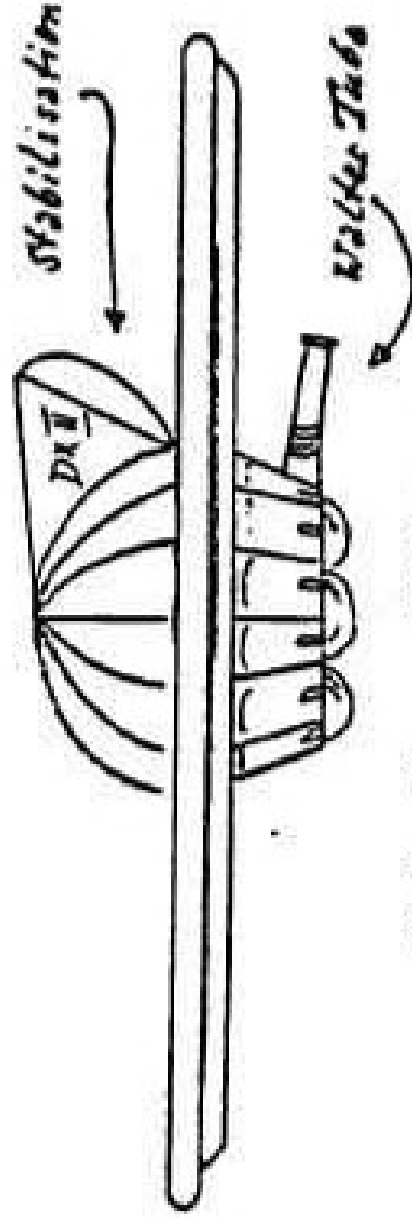

*Engine Room - 1 Technician  
below inflatable Rubber Buffers.*

On February 14, 1945, this type of craft, a vertical starter disc, attained in 2.4 minutes the exact height of 12000 m, and horizontal flight-speed of 2000 km per hour. Fuel problems were not yet solved then, because of "competition" with the V-rocket series. Note stabilization fin and Walter Tube. The "Walter Tube" had additional functions besides providing side stabilization. It also assured instant thrust at take-off as well as during horizontal flight. This craft carries 2 pilots in pilot room and a mechanic below.

# 2

# THE COANDA EFFECT

The Coanda Effect was discovered in 1911 by a Rumanian named, Henry H. Coanda. This effect enabled an aircraft to complete a hair-pin turn, which is highly unconventional.

If you are familiar with flying, you know how impossible it is to make this close formation turn. This violates every known Law of Aerodynamics.

With the Coanda Effect, a situation is created where the lift on the wing is increased, also benefiting the flow system of jet engines.

The jets then tend to follow a wall contour even as it curves away. Here is an example: invert a common sauce pan with rounded rim under a water tap and let the water flow over the bottom of the rimmed edge. (The pan should be inclined somewhat.) You will observe the water clinging to the lower rim and actually flow upward against gravity for a very short distance.

The Scientists tried to use this effect on a large prototype of the saucer-shaped craft, and it worked. The proof of the effect was

the fact that the German Saucer immediately took off and reached an unbelievable height in minutes, achieving tremendous horizontal speeds at Mach 4, with a reaching range of Mach 5 in just a few moments.

The problem of stability was then worked out.

Rumors had it that in the Black Forest of Germany, there were several research laboratories. These labs researched ways to eliminate gravity completely.

## UFO INVESTIGATION STARTS

The front page of the "Washington Daily News" on May 14, 1949 read, "THE U.S. AIR FORCE KNOWS WHAT FLYING SAUCERS ARE AND WHERE THEY COME FROM."

The byline stated, "They are a new machine utilizing gyroscopic principles, based in Spain, built by escaped German Scientists and Engineers."

As an additional footnote, the United States Air Force claimed responsibility under the Department of Defense for investigation of UFO's.

"PROJECT BLUE BOOK" was in operation from the year 1948. "Project Sign" and "Project Grudge" are also code names for the U.S. UFO Investigations of the past.

Air Force interest in UFO's is related directly to Air Force responsibility for the air defense of the United States. Procedures for conducting this program are covered by Air Force Regulation 87-17A.

The objectives of Project Blue Book were twofold. First, to determine if UFO's pose a threat to the security of the United States; and second, to determine if UFO's exhibit any unique scientific information or advanced technology which could contribute to scientific

or Technical Research.

In the course of accomplishing these objectives, Project Blue Book strove to identify and explain all UFO sightings reported to the Air Force. (The Air Force defines a UFO as any aerial object or phenomena which the observer is unable to identify.)

## REPORTED SIGHTINGS

During the year 1949, when the Washington Daily News headlines stirred most of the Nation, Project Blue Book reported that in 1948 there were a total of 156 sightings, and in 1949 there were 186 sightings of UFO's in the United States. Of the 156, 1948 sightings, seven remained in the category of 'Unidentified,' while out of the 186, 1949 sightings, 22 remained in that category.

It is interesting to note that multiplied numbers of newspapers throughout South America reported strange aerial objects during those years. These UFO's were described as large round disc-shaped, also cigar-shaped and spherical shaped, emitting large puffs of black smoke and making very loud clanging noises.

Several newspapers went so far as to report the sightings as appearing to be a wheel within a wheel (Ezekiel Chapter 1).

As a matter of historical fact, all Governmental Intelligence agencies have secretly probed the questions of Interstellar Space Craft, and the challenge of interworld visitors.

It has been projected that by the year 2000, interplanetary travel will be commonplace.

( Diffusion Radiation Fuel-Power-Pack )

The Argus-Rohr (Tube)

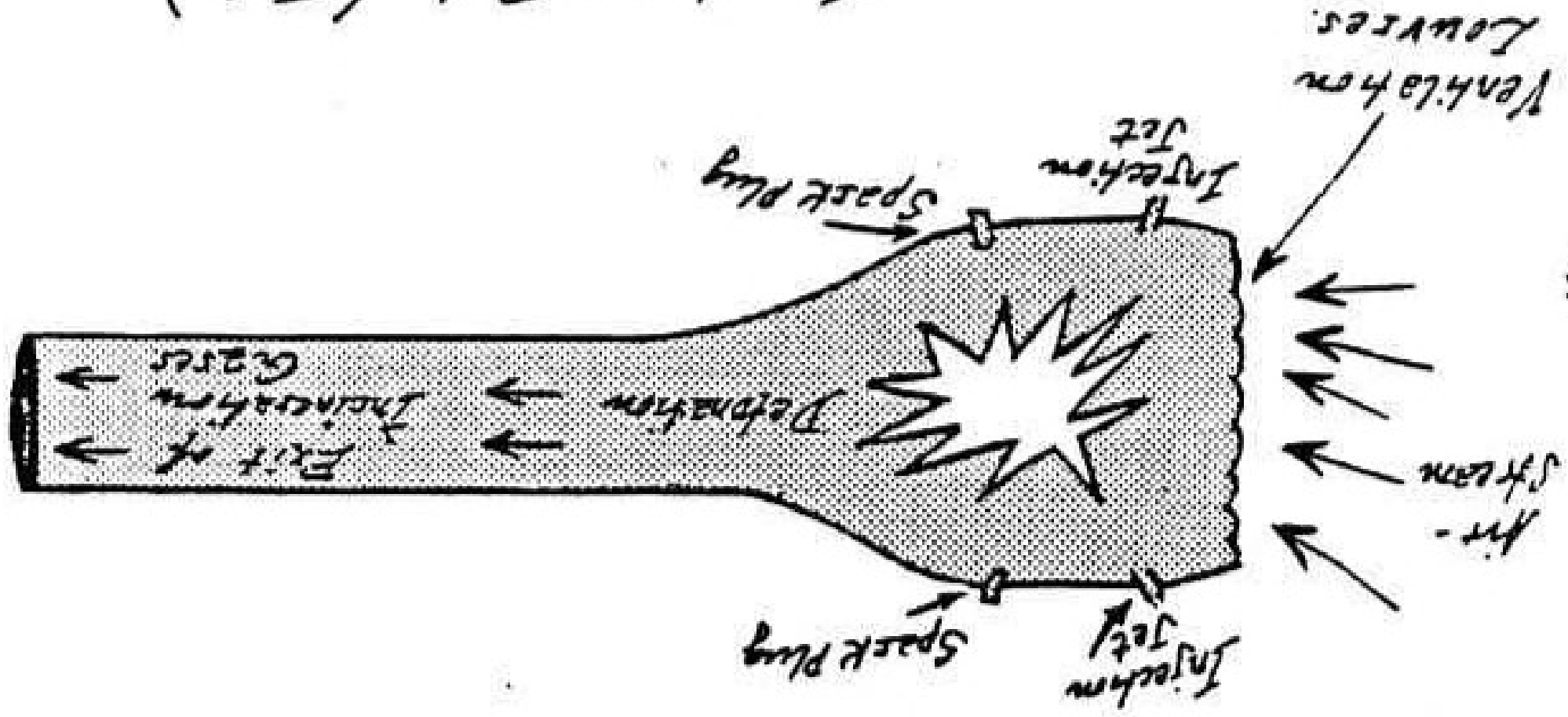

THE ARGUS-ROHR ( TUBE )

# 3

# HITLER'S WILDEST WEAPON

Information was released to the United States Intelligence Forces in November of 1967, which was part of the secret records captioned, "Hitler's Wildest Weapon."

In reality there were twelve secret devices in all. The first of these dreaded weapons was the flying disc. Adolph Hitler was planning to use all twelve of these devices against the Allied forces.

## JAPANESE INVOLVEMENT

Members of the Japanese high command were desperately attempting to procure a close relationship with the Fuhrer. They felt that if Nazi Germany won the war, Hitler might allow them to borrow these twelve dreaded weapons for use in the Japanese theatre of the war.

Little did they know that Hitler never trusted them, and would gladly have seized Japan had he won against the Allies.



# THE TWELVE WEAPONS

These are the twelve deadly weapons that Hitler's Scientists were creating:

## A Flying Disc

A Combat Tank (formed from one solid piece)

Sound Waves (which would destroy the mind)

Advanced Laser Beam

Flaming Artificial Cloud

Super Robot Bomb

Electronical Charged Cloud

Sensational Shell (to pierce armor)

Electromagnetic Km-2 Rocket

Paralyzing Ray Gun

Electronic Ball Lightning

The Flying Bottle, Tube, Sphere, etc.

These weapons were seen by the Allied Forces during their early experimental stages. However, none of these devices were perfected.

The Scientists who invented them, escaped to South America before the end of the war. Their intentions were to finish the flying crafts and use them to enter into the World Trade Market.

From time to time there are unusual accounts from people in various parts of South America who claim to have come into personal contact with these Scientists.

It is ironic that in the year 1982, information on these Scientists was leaked to the press. On occasion you will read about this in various tabloids in various parts of the World.

## HITLER'S INNER CIRCLE

Hitler's inner military circle included his personal adjutant, Bruckner, his press chief,



On August 20, 1958, "Neues Zeltlager", a weekly newspaper in Munich, printed an important article by Jan Holberg, entitled: -

# „UFOs gibt es nicht! Wohl aber: Augscheiben am laufenden Band!“

(“There are no UFO's! But: Flight Discs in Mass-Production!”)

Jan Holberg credits Hermann Klaus for most of the data contained in the article, which included these three designs of Flying Discs:

Flaschensystem, 2-Phasen-Isolierung

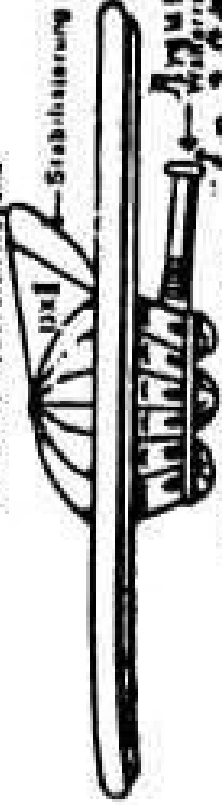

Stabilisierung

Arbeits-  
zeit 10-15 min

Maschinenbau, Techniker

unterstütztere Gummipuffer, später, 2-Phasen-Isolierung

4. Letzter Prototyp der „Schiffner-Hilberstein'schen Flugscheibe“ 1943/44

Am Ende des zweiten deutschen Typs (mit stabilisierender Leuchte) wurde ein Muster 12 im Jahre 1944 und dann im Jahr 1945 hergestellte Gummipuffer. Technische Probleme waren noch nicht gelöst - wegen der „Kampfbauart“ - für den Einsatz der Maschine wurde eine spezielle Bauart entwickelt.

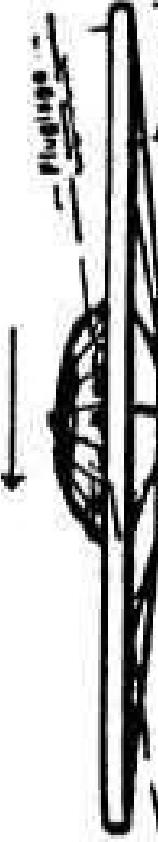

Fluglage

Arbeits-  
zeit 10-15 min

aufblasbare „Landpuffer“, kein Flug, sondern

Dieser Prototyp, ein flugfähiges Instrumentarium, hatte gleiche Flugeigenschaften wie die oben beschriebenen, nur beschränkt an der Reichweite. Das Prinzip des im Krieg eingesetzten „Flugscheibe“ waren stabilisierbar. Technische Probleme waren noch nicht gelöst und wurde eine spezielle Bauart entwickelt, später besetzt.

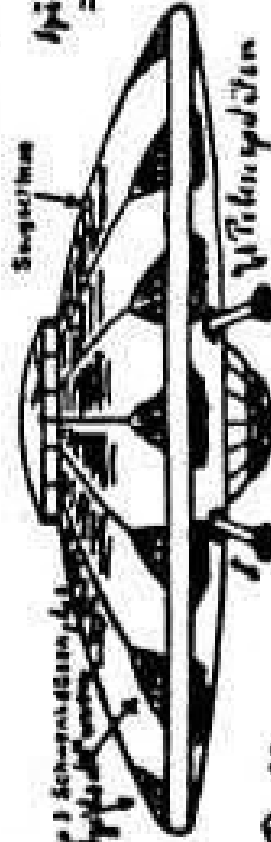

Suspensions-  
system

3. Schwebesystem  
Arbeits-  
zeit 10-15 min

Bellonzo

- Schiller - Meißner - Döhrer -  
Bier- und Landpuffer, unter unterstützter  
Gummipuffer, ein- und zweiphasig

4. Breiter Typ

entwickelt aus einem Flugscheibe der nach dem „Commodore“ ausgebaut. Drei Phasen der ersten, später stabilisierbaren, eingetragenen Bauart, etwa 14 cm.

# 4

## THE FLYING DISCS AND THE V-7

According to Dr. Klausner, the Germans planned to build a fleet of saucer-shaped craft with a basic motor design consisting of a series of blades on the underside.

They attempted a counter-rotation blade system, but quickly abandoned it when they discovered that counter-revolution movement is the condition created by motors or propellers going counter-clockwise, when for just a moment, there suddenly is no motion in either direction.

### THE V-7 IS BORN

The V-7 was not a rocket, it was a disc-shaped vehicle. The V-7 differed from other models built by Heimerball and Schriever.

Heimerball and Schriever's discs had visible floating parts and the V-7 did not. The V-7 was far different from any vehicle that had been conceived or developed.

The V-7 had rotating tubes plus a circle of bright flame, thus giving the illusion of a

bright shining disc.

The Soviet Union now has in its possession working models of the V-7. If the U.S.S.R. has intentions of perfecting the V-7, they will not take a chance on its discovery by flaunting it carelessly in their skies.

## SAUCER CRAFT CONSTRUCTION

According to Professor Hermann Klaus, research and actual construction of the flying discs is still quite prevalent in the Southern Andes of South America.

UFO reports have come to light through various media sources, including the Mexican National Press. These "Smoky Saucers" (as they are called by the people in South America) are unique among UFO sightings around the world.

While in flight, these craft make loud noises, shoot off orange flame and huge puffs of black smoke are emitted.

## SECRET GERMAN BASES

Information from world intelligence agencies has led to the revelations of nine secret German bases where the saucer-shaped craft are manufactured and serviced.

They are located in these areas:

The South Andes Region

The Argentine province of LaPampa

Triangular area of Bahía Blanca Cordoba & Salta

Chili

Termina, Sicily

Johannesburg, South Africa

Taymyr Lake, Northern Siberia

Milan, Italy

Reno, Nevada

# 5 THE U-209

Hitler was a staunch believer in the Aryan race. Ever since he was a young man, he had believed that this race came from a mystical land in the North Polar area.

He believed that this race existed in the "Hollow Earth" regions. He felt that the first Nordic Germans evolved from this inner-world; migrating out of the North Polar aperture in the distant past.

Adolph Hitler steadfastly clung to this belief throughout his entire life. As a result, he ordered a specially outfitted U-boat to be constructed for north polar exploration.

## U-209 VOYAGE

In the year of 1943 special charts of the north polar area were drafted and certain calculations were made for the expedition. Hitler thought that a U-boat, would be the Ideal means by which to enter the polar aperture.

In May of 1943 the German undersea boat U209, left the port of Kiel in Germany, its destin-

ation, the North polar region. Its mission, to find and enter the north polar aperture and make contact with the Aryan civilization living in the interior of the Earth.

Fantastic as it may seem, these secret orders issued by Hitler were part of his scheme to enlist the help of the Aryan race. He wanted to use them to produce a super race that would one day rule the world.

World War II German Naval records reveal that the U209 sank in May 1943. However, it was further noted that a second U209 (a U-boat of the Walther class) was also based at Kiel.

It is known that this particular U-boat was housed in a bomb-proof, heavily constructed concrete pen, and rigidly secured.

It was rumored that Hitler and close members of his staff left in such a U-boat, for a base supposedly established under the north polar ice cap.

Hitler directed that U-boat Commander, Heinrich Brodda, enter the opening through the great barrier ice fields. His orders stated that after he passed through the ice fields, they would find great open seas of warm water.

It was at this critical point in their journey when the compass needle began to dip. Upon entering the polar opening they encountered a great river basin of fresh sweet water.

While nearing the prescribed area, noted on the submarine's sonar gear, a strange blip appeared. This blip remained only a few hundred yards ahead of the U-boat - its course nearly parallel to that of the undersea boat itself.

Commander Brodda and two of his officers guessed this blip to be a whale. They decided to follow it and were amazed upon surfacing to see not a whale but an undersea Erdian patrol craft.

Traveling up river for several hundred miles, they came to a great city.

Within the walls of this beautiful world they discovered a highly advanced civilization. Having no desire to return to the surface world, there they remained.

There are references to this fantastic "Inner-world" region in such books as, "The Hollow Earth", and "The Smoky God."

## BELLONZO-SCHRIEVER-MIETHE

### First Type

(NOTE: Hand drawn from German patent assigned, by Carl F. Meyer, for his credit.)

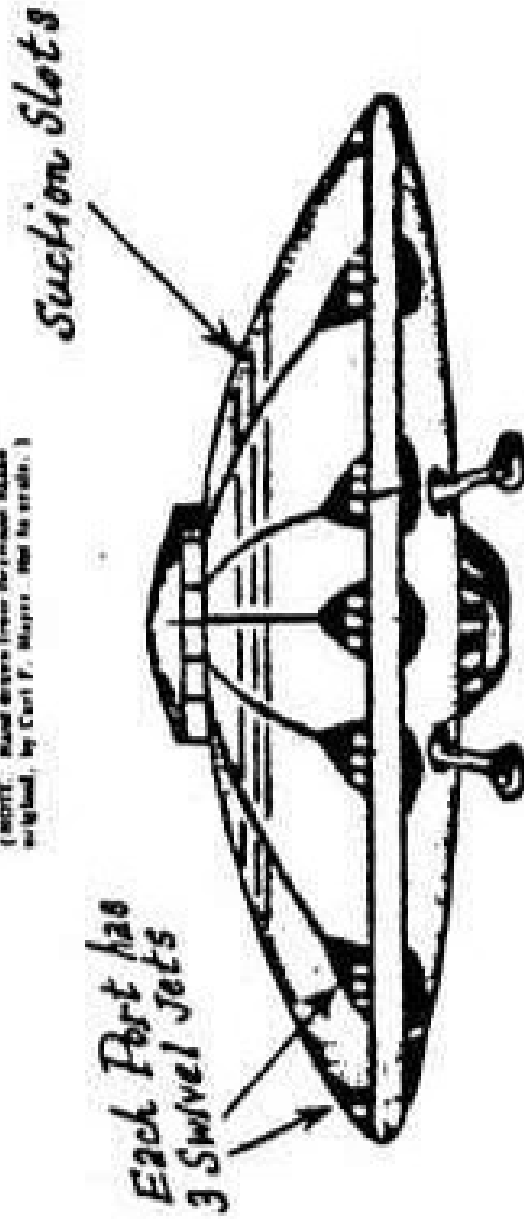

Diameter: 11-18 meters, according to strength and amount of the magnets, water and the screw-blades, including ring type.

Outer Construction: Titanium sheets of various strengths, all according to exact perfection of friction level. Or: modern fibreglass plastic plates, pre-formed.

Inner Construction: Light metal, including preformed plastic material.

Lower part: (Between letters h-s) open, as usual preformed cover above it, round sheet up to the section blades. Lower cone hangs solidly on horizontal carry-bars, so that effect of light-wing screws has to overcome only small air-resistance.

Fresh air suction: Either open ring slots or larger section slots. This will depend on motor power and diameter of the Flying Disc.



# "Flying Saucer" Design.

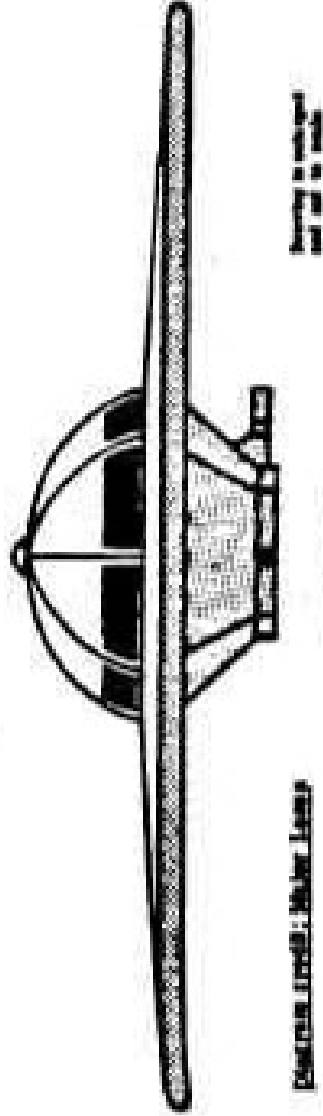

CONSTRUCTION: Walter Lantz

1947-1948

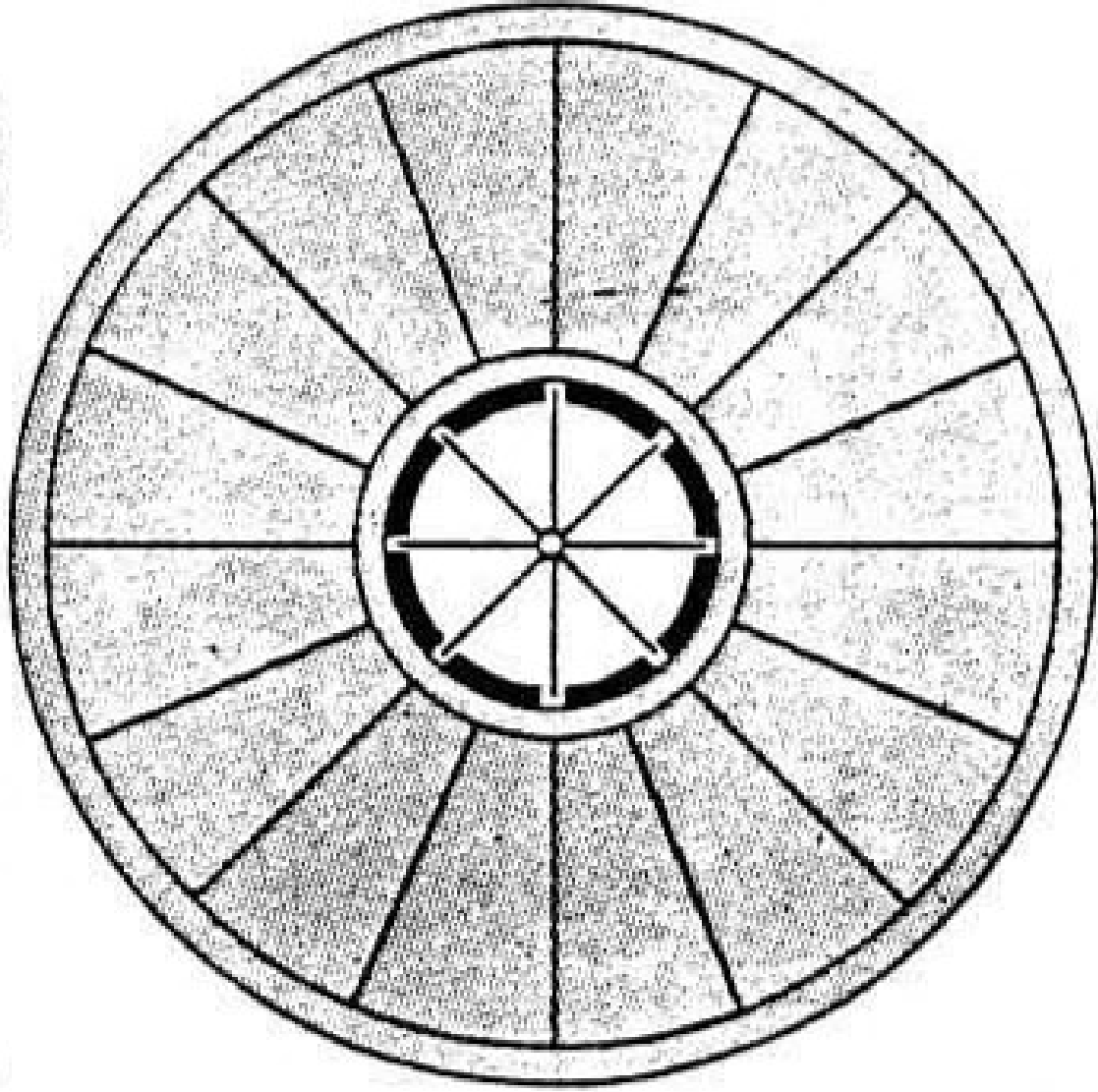

This drawing is from the book of the German military writer, Wolfgang Bauer, entitled "The Graces: Night and Day" (written by Bauer and Fritz Sch. under the pseudonym "General Engelmann"), published in Munich, 1944, by J. F. Lehmann Verlag, Munich, Germany.

# 6

# THE RENO UFO SIGHTING

The following event took place in Reno, Nevada, during a UFO Convention, July 1966, at the Centennial Coliseum.

This "Amalgamated Flying Saucer Clubs of America" Convention included leading researchers: Wayne Aho, Orfeo Angelucci, Dr. Dan Fry, Carl Anderson, George Van Tassel, Gabriel Green, and myself, Dr. Frank E. Stranges.

It was during this convention that I had an encounter with a Nazi saucer-shaped craft.

## MY PERSONAL ENCOUNTER

On Thursday morning, July 7th, the phone rang in my hotel room. The caller (wishing to remain anonymous) asked me to meet with him before the convention convened at the Centennial Coliseum.

When I met with him, he stated that he had followed my career for many years, and was pleased with my work. He cautioned me to look straight forward, and not to look at him directly at any time during our conversation.

His first question was, "Do you know any-  
27.

thing about German Saucers?" I informed him that all I knew was what I had read in UFO accounts from magazines and newspapers.

He then requested that I brief him on the "German UFO Crash" that took place in Helgoland, West Germany. This question was directed to the account that was written and reported at length in my book "Saucerama."

He seemed quite satisfied with my narrative on the Helgoland matter. Without warning he said, "Do you know that there will be a German Saucer about one-quarter of a mile from the Reno Airport Control Tower in the morning?" "It has already arrived in this area!" (Gabriel Green and several others had reported sighting a UFO high above the city early that morning.) He further stated that the German Saucer would LAND near the Airport in the morning. Then he turned and left the auditorium.

The following morning I took a taxi to the Reno Airport with a friend of mine. We had the driver let us off on the outskirts of the Airport. Trudging along a dusty road we approached an area that rose slightly and suddenly dropped into a shallow ravine.

To our great surprise, there it was...a saucer-shaped craft sitting on the ground on three short legs.

As we approached the craft, it appeared to be 50 feet in diameter, with a large outer rim. We noticed a ladder leading to a door that slid open.

A heavily built man with a deep scar on his cheek and dark heavy eyebrows stood at the opening. There was a brief exchange of German between my companion and him. He tried to hand us some U.S. currency as he explained that he wanted us to purchase food for him.

He continued to speak in German and I concluded that he was very desperate. As he spoke, he continued to watch the sky like a hawk.

Suddenly, he waved us off and the door slid

shut. We heard a hissing sound similar to that of equipment run by hydraulic power. My companion and I turned around and saw a police car approaching us.

The saucer whined like a jet plane coming in for a landing. The outer rim revolved and kicked up dust, dirt and gravel. It left the ground swiftly, however, there was an intense vibration. It then shot over toward the Control Tower and continued on until it was out of sight.

We remained in the ravine until the police car passed us by, and then went back to our hotel room and changed our dirty clothes.

This type of sighting has been reported not only by myself but many other responsible people from all walks of life in numerous parts of the world.

During my recent visit to West Germany, I was not too surprised to meet certain gentlemen who were familiar with my Reno UFO sighting.

They stated that before long, attempts would be made to contact South American Government officials, to establish a trade agreement that would be honored on an international level.

There was a note of caution as one gentleman said that such a vehicle could not be used as a weapon of war. He further suggested that the Aerospace Industry is in for somewhat of a shock, during this decade.

At this writing, reliable sources revealed that UFO reports have increased in many parts of South America.

Eyewitnesses claim to have seen Nazi Swastikas painted on the exterior of landed craft.

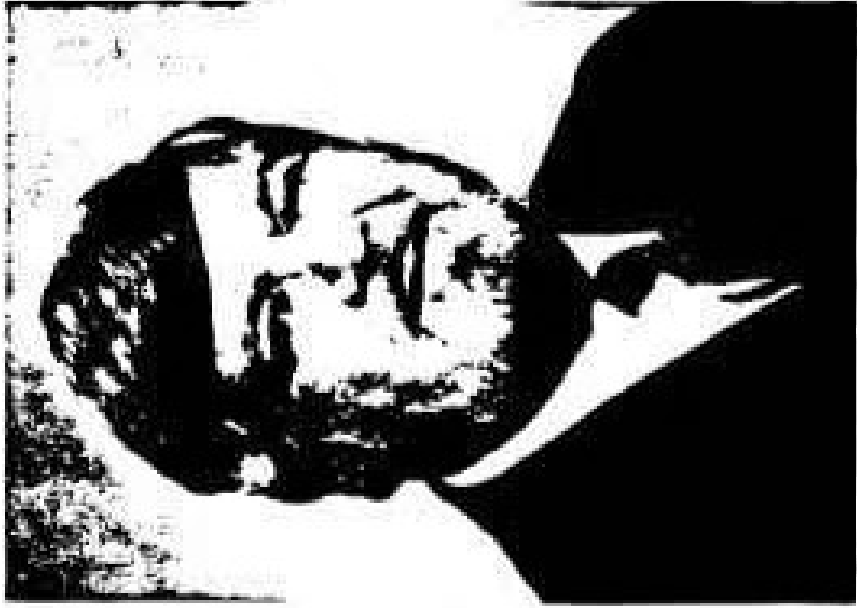

Dr. Frank E. Stranges

DR. STRANGES ASSOCIATIONS AND MEMBERSHIPS INCLUDE

*President, International Esophagus Society  
President, International Thoracic Surgeon  
Society of St. Luke the Physician, England*

*Institution for Social Psychiatry, Washington, D.C.  
Accredited Diplomat, American Academy of Professional Arts,  
Omaha, Nebraska  
Board, Science Federation, Green Cove Springs, Florida*

*President, National Investigation Committee on UFOs  
Life Member, Executive of Psychic Investigators, Oklahoma*

PARTIAL LIST OF HONORS INCLUDE

*Named as "MOTY WIND IN BELGIUM" - 1977, 1978  
Assistant Deputy Director, California State Marshall's Association  
Communist Leader and Nativist, American - 1975, 1976  
Pillar of - Appreciation from Christian World, South Korea - 1977  
- Honor, awarded from Government of South Korea - 1977  
- Honor, awarded by National Psychiatric Council,  
South Korea - 1977  
- Appreciation by Korean Branch of the International  
Esophagus Society - 1977*

*Magician - Medium - World Traveler - Motion Picture Film Producer -  
Special Investigator - Author - Lecturer - Educator -*

OTHER BOOKS BY DR. FRANK E. STRANCES:

THE STRANGER AT THE PENTAGON

THE UFO CONSPIRACY

FOR A FREE CATALOG OF THESE AND OTHER  
IMPORTANT WRITINGS...SEND A SELF-ADDRESSED,  
STAMPED, BUSINESS SIZE ENVELOPE TO:

U.F.O.

P.O. BOX 5

VAN NUYS, CALIFORNIA, U.S.A.

91408-0005

# EPILOGUE

I have studied the UFO mystery since the year 1945. I have logged many thousands of miles in my travels around the world. I have interviewed men and women from every walk of life.

I have been involved in top-level investigations. The conclusions I have drawn are not necessarily unique to me. However, I must make the follow statement without reservation.

Anyone who maintains that there is only one explanation to the UFO mystery is one hundred percent in error. In order to properly evaluate the scope of this mystery, it is imperative that we seek out every source possible in an effort to distinguish between fact and fiction; between that which is true or false; between that which is good or evil.

It is interesting to note that there have been numerous bodies positively identified as that of Adolph Hitlers'. Taking these reports as a whole, mathematically speaking, maybe two or three people at the most could have the same cranium measurement and dental work. Not over 38, as has been POSITIVELY proven.

Still, rumors persist even today that Hitler is still alive and living comfortably somewhere in South America. We cannot rule this possibility out.

Also, these following facts recently reported on CBS-TV"60 MINUTES"cannot be denied: Nazis who were in charge of Concentration Camps are now living in the United States under the protection of the Central Intelligence Agency, and some are even employed by same.

Let us maintain an earnest and constant vigil at all times, and perhaps someday soon we will hold in our hands the very key that will not only unlock more of these German Saucer Secrets, but also the secrets of the Universe!

# Nazi Secrets

**NAZI UFO SECRETS AND BASES EXPOSED delves into a classified 'TOP SECRET' project developed by German Scientists during and beyond World War II.**

**Read how "Hitler's Secret Weapon" could have changed the course of history, and why there is still a cover-up regarding the "Secret Saucers!"**

**Read the interesting testimony by former German Scientists who perfected this experimental 'craft' after they escaped to South America.**

**You will be amazed at the Scientific data and eye-witness accounts on this most startling subject!**

