

...the ...

...the ...

...the ...

...the ...

...the ...

...the ...

...the ...

...the ...

...the ...

...the ...

...the ...

...the ...

...the ...

...the ...

...the ...

...the ...

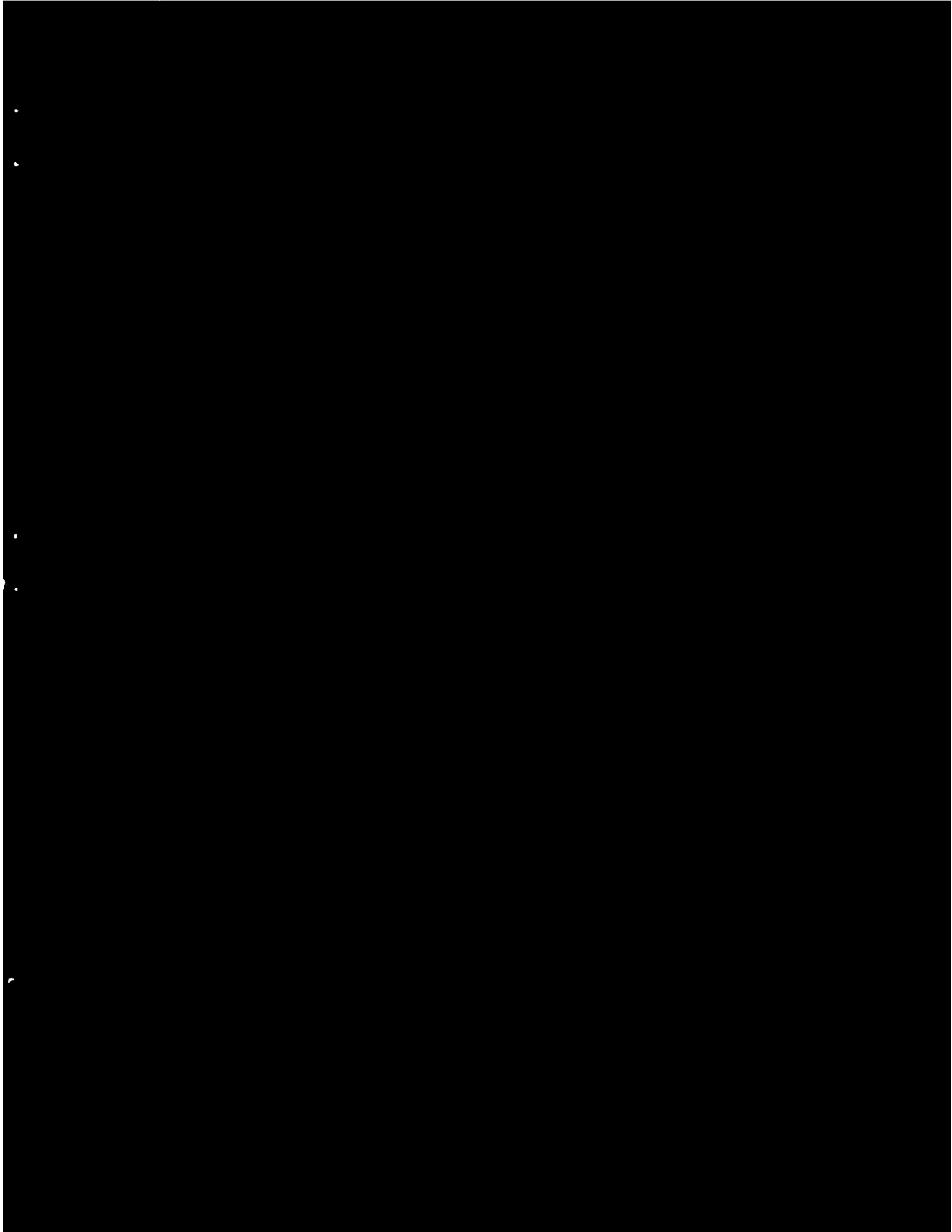

Implantable Transponder

Product Description:

The Implantable Transponder is a passive radio-frequency identification tag, designed to work in conjunction with a compatible radio-frequency ID reading system. The transponder consists of an electromagnetic coil and microchip sealed in a tubular glass enclosure. The chip is preprogrammed with a unique ID code that cannot be altered; over 34 billion individual code numbers are available. When the transponder is activated by a low frequency radio signal, it transmits the ID code to the reading system. Independent testing has shown the transponder to be safe and easy to implant.

Although specifically designed for implanting in animals, this transponder can be used for other applications requiring a micro-sized identification tag.



Specifications:

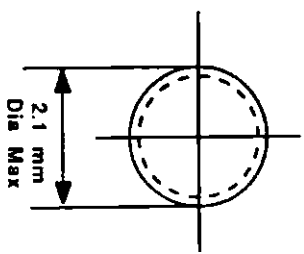
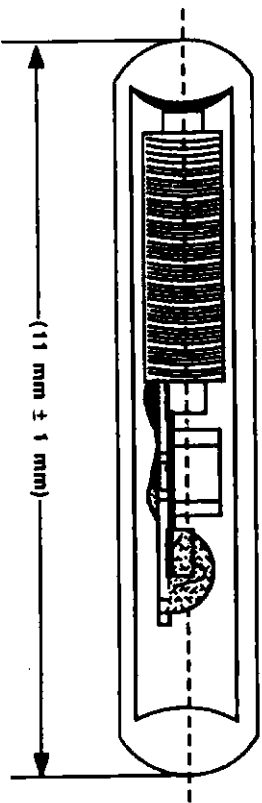

Future Shock: 'Biochip' Science Fiction

By Teresa Allen

1/1 member writes

Don't reach for your wallet at the

check-out counter.

After your food items have been priced,

read and tagged, simply pass your hand

over the computer code scanner used on

the product, and the bill will be auto-

matically deducted from your checking

account.

Or consider this: A powerful "biochip"

makes from living protein that, once sur-

geally implanted in the brain, could

make it possible to program or "upload"

the mind — without having ever cracked

open a book.

Impossible? The plot of a science fic-

tion novel?

The technology, to accomplish such

feats, is already here or, as in the

case of the living biochip, in the process

of being developed, says Tim Willard, ex-

ecutive director of the World Future Soci-

ety, a Washington, D.C.-based organiza-

tion that claims 27,000 members

worldwide, including "Future Shock" au-

thor Alvin Toffler.

Strong aversion

"But just suggest something like an im-plant in humans and the social outcry is tremendous," Willard said. "While peo-ple over the years may have grown ac-customed to artificial body parts, there is definitely a strong aversion to things be-ing implanted. It's the Big Brother is watching concept. People would be afraid that all of their thoughts and movements were being monitored. It wouldn't matter if the technology was there or not. People would still worry."

Even the idea of implanting dogs and cats with identifying microchips — as the Martin Human Society announced it would do last week — is a concept we're hardly "new" and Diane Alverno, direc-tor of the Novato animal shelter.

"We want to make sure it's rights for the animals, and that the community is willing to accept this new technology," she added. The chip, about the size of a grain of rice, is implanted with an identi-fication number that corresponds to the name, address and telephone number of its owner. The identification pops up on a screen when the animal is scanned by a computer wand. It is the first animal implant in the country to use the system.

One person telephoned the society to say she felt the implants were "unnatural" and would.

"And there's no doubt about it — im-planting an animal with a computer chip is a pretty unnatural thing to do," Alverno told the caller.

"But it's also unnatural, obvious really, that 15 million stray animals are de-stroyed in the country every year."

Future

From page A1

sidering human application.

"There's no need to (apply the technology to humans)," he said. "The human fingerprint is unique. Animals don't have a unique identi-fier."

But Willard, managing editor of the World Future Society's bi-monthly magazine called "Futurist," said the technology behind such a microchip is "fairly uncomplicated" and with a little refinement, could be used in a variety of human applica-tions.

"Conceivably, a number could be assigned at birth and go with a per-son throughout life," Willard said.

Most likely, he added, it would be implanted on the back of the right or left hand for convenience, "so that it would be easy to scan."

"It could be used as a universal identification card that would re-place credit cards, passports, that sort of thing," Willard said. "At the check-out stand at a supermarket, you would simply pass your hand over a scanner and your bank ac-count would automatically be deb-ited."

More importantly, Willard said, "It could be programmed to replace a medical alert bracelet. For example, at the scene of an accident, a medic could scan the person to find out his or her recent medical history, alter that, a receipt to get in touch with the person's physician, such a mi-crochip would be especially valuable if the person was unconscious."

In another application, such a mi-crochip could replace the need for house or car keys.

Within 15 to 30 years, the "regu-lar" microchip will be out-classed by a biochip made out of living protein, according to Willard.

Compared to the microchips of to-day, "it will be infinitely smaller and more intricate," he said. But the potential for "a range of functions that will boggie out minds" carries with it the danger of abuse — partic-ularly over the issue of privacy.

A human microchip identification system, Willard said, "would work best with a highly centralized com-puter system where one identifica-tion number would gain access to medical and academic records, home security — all kind of things. But under the arrangement, as you can imagine, the security risks are some-what intense."

Journal in a Nutshell

The Main Independent Journal (ISSN 0361-3301) is published weekly through Friday and Saturday and Monday mornings by California Messenger, Inc. (50 Alameda del Prado, Novato, CA 94945). Second-class postage paid at Novato, CA and additional mailing offices. POSTMASTER: Send address changes to Main Independent Journal, P.O. Box 151790, San Rafael, CA 94915. General Information: (415) 883-1808. In Southern Marin, call toll-free (714) 361-3282.

Editor: Peter A. Novato
Publisher: Catherine Babin
Associate Publisher: Jay Breckenridge
Managing Editor: Robert B. Babin
Business Manager: Robert B. Babin
Advertising Director: Alan Johnson
Personnel Director: Lewis B. Call
Director of Marketing Services: Robert B. Babin
Production Manager: Robert B. Babin
Controller: Robert B. Babin

"People tend to be romantic about their independence and privacy, but the reality is that most information pertaining to education, credit his-tory, whatever, is readily available to just about anyone who asks. Any-one who has ever gone through a credit check knows this."

Another futurist found the con-cept of microchip implantation in-teresting.

"It reminds me of tattooing con-centration camp victims in World War II," said Robert Mittman of the Institute for the Future — a non-profit research and consulting firm in Menlo Park.

"He said there were better methods of identifying people than "violating the integrity of their skin."

"Personally, I have problems with it. If it's ever used on humans, it won't be very widespread. People would end up sacrificing some civil rights," he said.

Martha Kegel, associate director for the American Civil Liberties Union for Northern California, ex-pressed concern about how medical and other private records would be kept from "inquiring minds." It such a system existed.

Journal in a Nutshell

(50 Alameda del Prado
Novato, CA 94945
(415) 883-1808

San Rafael, CA 94915 1296

Mailing address:
P.O. Box 151790
San Rafael, CA 94915 1296

Microchip 'tags' will point to pets' owners

By NIKI GERVAANTES
Copy News Service

LOS ANGELES — Computer-compatible cats and canines are about to be unleashed in Los Angeles.

In a novel attempt at reducing an overwhelming population of lost dogs and cats, the Los Angeles City Council yesterday voted to implant some pets with microchips programmed with identification information.

Beginning in March, the high-tech ID tags will be implanted in the estimated 14,000 pets adopted each year from the city's six animal shelters. Animal control officials will also start a campaign urging all pet owners to go to city shelters and have the chips put into their dogs and cats.

The cost? About \$4.50. And it hardly hurts.

"It's just like getting a shot," assured Robert Rush, general manager for the city's Animal Regulation Department. "We use a syringe. It's quite easy. We're talking seconds here."

Council members did vote 10-3, however, to put the bite on pet owners by raising impound fees to help pay for the \$123,000-a-year program. The cost of claiming a

lost dog from a city shelter will jump from the current \$10.50 to \$25 the first time, \$35 the second and \$45 each time after that. The redemption fee for cats will rise from \$8.50 to \$13.50.

The sterilized glass microchips will be placed just beneath the skin on the back of the neck for dogs and cats. An ID number on the chip will pop up on hand-held scanners and then feed into a computer loaded with the name, address and telephone number of the pet's owners.

"You know how the scanners work in grocery stores?" Rush said. "It's the same technology. It just hasn't been applied to this kind of thing. But the city of Los Angeles has always been out in the front of things."

Los Angeles' microchip program is the first in a big city. Only one other jurisdiction — a small town in Marin County — uses the implants. Rush estimated the city will be able to return 13,000 more pets

thanks to the microchips. Last year, only 5,700 of the 90,000 pets at city animal shelters were claimed by owners. About 14,000 were adopted by new owners.

City shelters get as many as 40,000 calls a year from owners looking for lost pets. Most owners don't know where shelters are located, and one reason many pets go unclaimed is that they are returned by good Samaritans to shelters in far-flung parts of the sprawling metropolis.

Vets chip in for pets

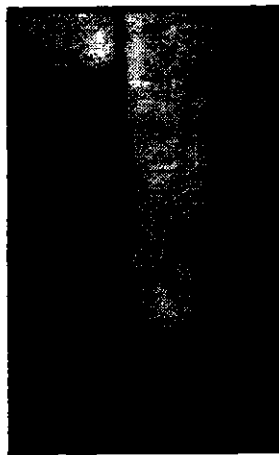

Under the skin: The microchip ID implant is the size of a grain of rice.

Tiny implants can provide foolproof ID

By MARK SAUER
Staff Writer

Our precious pet iguana has turned up missing, and the guy down the street is sud-

denly showing off a new reptile that looks suspiciously familiar.

Now, how would you be able to positively ID an iguana?

With a microchip, of course. Veterinarians in San Diego and across the country are implanting

microchips under the skin of pets and exotic animals as a foolproof method for positive identification.

Dr. Bob Stonebreaker, a Del Mar veterinarian, reports that the microchipping of all ostriches

and emus in San Diego County is virtually complete.

"It was a big job; must have been a couple thousand or more to do," said Stonebreaker, who breeds the giant birds as a side-

line. The veterinarian said "a lot of ostrich rustling occurs in this county. These birds are worth a

lot of money, and this is a sure-fire way people can ensure their birds are permanently ID'd."

Dr. Jeff Jenkins, meanwhile, has been targeting pot-bellied pigs.

"You can't tattoo 'em — their skin is black," noted Jenkins, a Mission Valley vet who special-

izes in birds and exotic pets, including reptiles and the popular pigs.

"Besides, tattoos can be altered. The microchip solves the problem."

About the size of a grain of rice, the microchip is implanted by means of a simple injection, no

anesthesia required. It contains an ID number that is read by a hand-held scanner; the number is

matched to the animal owner's file at the chip company.

The chip, which is harmless to the animal, lasts for decades and

need never be disturbed. There is no power supply or any moving parts to worry about.

Many dogs who slip their col-

See implants on Page C-5



Unusual injection: Wizzard, an alpine goat, gets a microchip implant from animal technician Kim Williams. Zoo worker Boo Shaw assists, and Catherine Yerber observes.

'Eye in sky' to track kids a teen horror

By Charles Kelly
The Arizona Republic

Jack Dunlap envisions his eye in the sky as a way to rescue snatched children, but it sounds like a teen-age nightmare.

You, Joe Teen-Ager, have a computer chip buried in your body, and a satellite in the sky tracks you wherever you go: to your girlfriend's house, to the local poolroom or to the beer party in the desert.

Whenever Mom or Pop get worried, the police are dialed and asked to track you down on their computers.

Of course, Dunlap didn't come up with his KIDSCAN idea so that it could bird-dog teen-agers.

The system is supposed to help find children who have been "picked up, transported, molested, abused, raped and murdered," he says.

Dunlap, who runs Arizona West Film Productions Inc. in Tucson and works as a private investigator when the film business gets slow, thinks he has hit on a lifesaver.

"The most important thing is to save the children," he says.

Each child whose parents signed up for KIDSCAN would get a computer chip



Steve Marcus/Beckel for The Arizona Republic
Jack Dunlap says his KIDSCAN system, if developed, would help parents locate children who were missing. He is flanked by Eloise M. Yarnes (left) and Lorna R. Lujan at Tucson's Optical Electronics Inc., which will build a KIDSCAN prototype if Dunlap can finance it.

planted under the skin and an identification number.

The chip would transmit a signal that would bounce off a satellite and be picked up by police on a computer-screen map.

A parent with a missing child could call

the police, give the KIDSCAN number and have the child traced. Police everywhere would have the equipment, so you could find a child anywhere.

But if Dunlap's dream is realized, it will — See B1A, page B3

Idea of tracking kids via chips could be teen nightmare

— B1A from page B1.

cause some troubling privacy problems, said Louis Rhodes, director of the Arizona chapter of the American Civil Liberties Union.

The police could use the system to enforce curfew laws or trace the movements of teen-agers who had not agreed to such scrutiny, he said.

"It's always dangerous to have so much information given to the police," Rhodes said.

Detective Charles Marino, a veteran of the missing-persons division of

the Phoenix Police Department, acknowledged that some parents would be concerned about the "Big Brother" aspects of KIDSCAN.

But the concept is attractive, Marino said.

"Any technology that can be used to detect missing children and children that are in danger would be welcomed," he said.

Dunlap's project is just in the talking stage. He's trying to raise money to have a prototype built.

At one time, he said, he had some Pennsylvania investors prepared to

He received encouragement from employees of Martin Marietta Energy Systems Inc., which runs the Oak Ridge National Laboratory, in Oak Ridge, Tenn.

Dunlap said officials there first told him they would build the prototype, then backed out.

"It was like a James Bond movie," Dunlap said. "It was like they had been told to shut up and stay away from it."

When the lab people sidestepped the project, his financial agents made

themselves scarce, Dunlap said.

"It was really weird," Dunlap said. "This sort of knocked me for a loop."

Joe Culver, a lab spokesman, said there wasn't anything weird about it.

Lab people did speak to Dunlap about a microchip they are developing, he said. Scientists want to put the chip on "killer bees" to track them as they sweep up into the United States from Mexico.

But the chip hasn't been fully tested, Culver said, so the lab can't make a commitment to Dunlap.

"It's very premature," Culver said.

Implants

C-5

Microchips are sure-fire way to identify pets

Continued from C-1

Jars and escape are caught and then destroyed at pounds and animal shelters because there was no way to locate the owners, Stonebreaker said. Microchips can solve that problem, and shelters here and elsewhere have taken to scanning strays in an effort to locate owners.

In the chips

The microchips are placed in standard places on animals, Stonebreaker said: above the left shoulder blade in four-legged animals; over the left breast muscle in exotic birds; and behind the left neck muscle in very large birds.

"The microchips are undetectable without a scanner," said Stonebreaker. "They can be seen by X-ray, however."

Although several companies here and in Europe manufacture and sell microchips and scanners, the most popular model is made by American Veterinary Identification Devices (AVID), a company based in the town of Norco, near Riverside.

After a decade of development, AVID's microchips have been available to the public for about two years, said Army Havey, marketing director for the company. The scanners needed to read

an animal's ID number off the chip cost \$1,250 apiece, said Havey. That cost could be a reason microchips have yet to really catch on among veterinarians.

When a vet becomes the first in his community to buy a scanner, however, AVID sends along a second one at little or no cost so the local animal shelter will be able to take advantage of the technology.

Pet owners are charged between \$15 and \$40 to have microchips implanted in their animals, Havey said. (Stonebreaker, who charges \$35 for the service, said the chips themselves cost about \$8.50.)

Havey said the chips have been especially popular with people who own horses and other farm animals, because branding is expensive. Brands also can fade or be altered, and they generally aren't recognized over state, or even county, lines.

Veterinarians at the San Diego Zoo have found microchips to be useful in distinguishing between reptiles, birds, bats and certain hoofed animals that are difficult to tell apart, said spokesman Jeff Jouett.

"When you buy a pig from me, it comes microchipped," said Collette O'Grady of Fallbrook, who breeds Vietnamese pot-bellied pigs as pets.

"Farm pigs usually have ear tags or tattoos. But since I'm breeding quality pets, I use microchips. People don't want an ugly tag," O'Grady said. "People who take their pigs to show routinely use microchips to identify them these days."

Pets

FROM PAGE A9

Only one other jurisdiction — a small town in Marin County — uses the implants.

Rush estimated the city will be able to return 13,000 more pets thanks to the microchips. Last year, only 5,700 of the 90,000 pets at city animal shelters were claimed by owners. About 14,000 were adopted by new owners. The rest were destroyed, Rush said.

City shelters get as many as 40,000 calls a year from owners looking for lost pets. Most owners don't know where shelters are located and one reason many pets go unclaimed is they are returned by good Samaritans to shelters in far-flung parts of the sprawling metropolis.

Lost identification

Pets also often lose their ID tags when lost. Microchips remedy that problem. The program also provides a central computer listing of all pets that can be used by each shelter, Rush said.

"It's not unusual for a pet lost at the beach to end up in east (San Fernando) valley," he said. "People don't know where to call for them."

Although the increased fee approved Friday can be waived for senior citizens and low-income residents, several council members worried that the hike would discourage pet owners from claiming their dogs and cats.

"Raising the fees makes it harder to get animals out of the shelter," said Westchester-area City Councilwoman Ruth Galanter.

A novel ID: Implant plan for pets OK'd

By Niki Cervantes
ORLEY NEWS SERVICE

Computer-compatible cats and canines are about to be unleashed in Los Angeles.

In a novel attempt at reducing an overwhelming population of lost dogs and cats, the Los Angeles City Council voted Friday to implant some pets with microchips programmed with identification information.

Beginning in March, the high-tech ID tags will be implanted on the estimated 14,000 pets adopted each year from the city's six animal shelters. But animal control officials also will start a campaign urging all pet owners to go to city shelters and have the chips put in their dogs and cats.

The cost? About \$4.50. And it hardly hurts. "It's just like getting a shot," assured Robert Rush, general manager for the city's Animal Regulation Department. "We use a syringe. It's quite easy. We're talking seconds here."

Council hike impound fees

Council members did vote 10-3, however, to put the bite on pet owners by hiking impound fees to help pay for the 123,000-a-year program. Claiming a lost dog from a city shelter will jump from the current \$10.50 to \$25 the first time, \$35 the second and \$45 each time after that. The re-

You know how the scanners work in grocery stores? It's the same technology.

— Robert Rush, Animal Regulation Department, City of Los Angeles

demption fee for cats will rise from \$8.50 to \$13.50.

The sterilized glass microchips will be placed just beneath the skin on the back of the neck for dogs and cats. An ID number on the chip will pop up on hand-held scanners and then feed into a computer loaded with the name, address and telephone number of the pet's owners.

Grocery scanners

"You know how the scanners work in grocery stores?" Rush said. "It's the same technology. It just hasn't been applied to this kind of thing. But the city of Los Angeles has always been out in the front of things."

PETS/A10

Animal control officials introduce microchip implants for pets.

By RICHARD BAROOS
Sun Staff Writer

DEVORE — Pin-sized microchips are being implanted in cats and dogs to save them from untimely deaths at county-operated animal shelters.

"It's permanent identification for your animal," animal control supervisor John Papp said Wednesday, when the first electronic data tag was implanted in a dog named Nabos.

The dog didn't even flinch as the tiny chip vanished between his shoulder blades.

Chips are available to any pet owner willing to pay \$20. Because of the fee, the voluntary program won't cost taxpayers a cent, said Papp.

Animal control officers will

implant chips at county shelters in Big Bear Lake and Devore. It's cheap insurance, said Papp, shelter overseer.

Strays are kept at county shelters at least three days so owners can claim them. But only 25 percent of the dogs — and 1 percent of cats — get reunited with their owners. The rest are put to death unless adopted.

The new tags are supposed to improve all that. Each carries a name-digit number referring to authorities to the owner's address and phone.

Strays will be checked twice with a hand-held electronic scanner, Papp said.

Dozens of similar tagging programs are being conducted throughout the nation. Among the closest locations are Riverside and Orange counties.

In San Bernardino County, dog owners who buy microchips still must purchase regular li-

censes. The electronic option offers added advantages. "Somebody isn't going to be able to steal your dog, take the tag off, and claim the dog is their own," Papp said.

And vicious animals will be injected with the electronic tags to help persuade their owners to keep them locked up.

"If a (vicious) dog is picked up, we'll know right off the bat. And if the owners have two anti-mals, they can't pull a switch on us. We'll know right off which animal was out."

The tags are manufactured by AVID, a Norco-based firm. because its scanners read three of the four chips in use in the United States, said Papp.

The tags won't please everyone, said Scott Gragon, AVID's national sales manager. "Anybody who doesn't want their animal traced back to them won't like this."

The microchip is smaller than a dime and is implanted between the shoulder blades of an animal. Microchip implants at Devore Animal Shelter, 1977 Shelter Way, Devore. Hours are 10 a.m. to 6:30 p.m. weekdays and 10 a.m. to 5 p.m. weekends.

CHIPPING IN



HIGH TECH TAGS

Ken Hey holds down Apollo, the cat, while Scott Gragon, injects a microchip for identification purposes. Gragon is a national sales manager for AVID, the company that makes the microchips.



Photo by DAVID CHAMBERLAIN for the Sun

T H E O R A N G E C O U N T Y
Register

Friday, January 8, 1993

The Orange County Register

Metro

NEWS FOCUS

Microchip implants aren't the perfect pet ID

By Debra Warner
The Orange County Register

James Patanella had a happy reunion with his dog Bear on Tuesday. The shaggy sheepdog mix was lost, but the Orange County Animal Shelter traced Patanella by reading a microchip implanted between the dog's shoulder blades.

"Before I even knew he was missing, I had a message on my phone machine," said Patanella, of Garden Grove.

A happy story — the kind microchip companies love to tell. Tiny chips implanted in pets help

animal-control officers reunite lost or stolen animals with their owners.

But Bear's rescue was not as assured as it sounds. With three incompatible types of microchips on the market, he could have ended up at a shelter equipped with an incompatible scanner and been put to death — one of millions of pets killed each year for lack of identification.

Microchips, which cost up to \$70 for insertion and lifelong registry, can save lives, solve legal disputes over ownership and even

Please see PETS/2



Daniel A. Anderson/The Orange County Register

James Patanella of Garden Grove is reunited with his sheepdog mix, Bear, on Tuesday at the Orange County Animal Shelter after shelter workers identified him by scanning a microchip implanted between Bear's shoulder blades. The dog was not wearing other identification when he was lost.

Register

PETS: Some experts want unified ID system

FROM 1
prevent fraud in petbred regis-
tries, animal welfare and industry
experts say.

But they're not foolproof alterna-
tives to the low-tech collar tag.

"It's very important that the
companies and the veterinarians
be real straightforward with peo-
ple and be clear about what they're
buying," said Dr. John Hamill of
Laguna Beach, president of the
California Veterinarian Medical As-
sociation.

Take Patanelia, for example.

"My understanding is that the
state of California would scan ev-
ery animal they bring in. If I ever
move, it would still work, because
they would call the vet," Patanelia
said.

That's not the case.
Patanelia could move to an area
with a shelter that does no scan-
ning or one that chooses a different
microchip system. Some shelter
directors said it's impractical to
check each dog and cat with sever-
al scanners.

"We're talking about large num-
bers of animals, and people who
have a lot to do," said Kathy Jenks,
director of the Ventura County De-
partment of Animal Regulation.
"We're all overworked and under-
paid."

Pat Miller, director of operations
for the Marin Humane Society,
said, "I'm not willing to ask my
staff to scan with two or three scan-
ners." Last spring, the National
Animal Control Association, mem-
bers of which include animal shel-
ters and humane societies, sug-
gested a boycott of microchips un-
til the companies agree to share
enough information so any chip

So you're giving up the
benefit of this wonderful
technology so you can all
read the one that's inferior.
I think it would be better
to have a side-by-side
testing by all shelters or
other organizations. The
best technology will
win. **99**

**InfoPet senior account
executive Lindy Harrison**

could be read by any scanner.

"The companies have paid lip
service, but there hasn't been any
real effort toward compatibility.
They're out there selling like crazy
and hoping the other guys will go
broke," said Edward Prince, edi-
tor of the National Animal Control
Association News, based in subur-
ban Seattle.

Hamill is more optimistic that the
microchip industry will develop a
statewide and eventually an inter-
national standard.

"I believe the companies will ul-
timately see it's good business to
cooperate," he said, adding that a
universal scanner could open new
markets.

Registries for purebred dogs or
cats, for example, might require
microchips for their members if
they were assured that the animals
could be identified anywhere. In
pet stores, the chips could function
as bar codes do for grocery items.
Dr. Hannis Stoddard, the veteri-
narian who founded American Vet-

erinary Identification Devices, or
AVID, in Norco, and Darryl Yurek,
founder of Destron-IDI in Boulder,
Colo., said they do want to develop
a standard system.

Not so with the third company,
InfoPet Identification Systems. A
spokeswoman said her company's
chips and scanners work from a
farther distance. Animals can sim-
ply be walked past a scanner rath-
er than examined closely with a
handheld scanner, said Lindy
Harrison, an InfoPet senior account
executive.

"So you're giving up the benefit
of this wonderful technology so you
can all read the one that's inferi-
or," Harrison said. "I think it would
be better to have a side-by-side
testing by all shelters or other or-
ganizations. The best technology
will win."

Microchips came on the pet
scene in 1967, when International
InfoPet Systems, based in Agoura
Hills, started marketing a chip
made by Destron-IDI.

In 1991 the market got hot and
hairy. InfoPet changed hands and
became InfoPet Identification Sys-
tems, and the new owners, based in
Minnesota, started carrying a dif-
ferent type of chip, made by Ger-
man company Trovan. Destron-
IDI started marketing its own
chips. And AVID entered the fray
with a third type of chip.

Two years later, the result is
what one industry observer de-
scribes as a "mosaic of technol-
ogy." Orange County, for example,
uses an AVID scanner. Ventura
County uses InfoPet, and Los An-

More on microchips

Microchips are the size of a long
rice grain and cannot be seen or
felt once implanted.

Microchips can be implanted in
dogs, cats, birds and other ani-
mals — usually in the neck or
shoulder-blade area.

Microchips do not transmit radi-
ation or affect the animal's
health.

A microchip scanner reads the
chip's radio wave, which shows
the animal's individual identifica-
tion number. The microchip reg-

istry lists either the veterinarian
or animal shelter that implanted
the chip, which keeps records of
the animal and its owner; for an
additional fee, the registry keeps
up-to-date information on the
owner's location.

For more information on
microchips, contact your veteri-
narian. Implantation usually
costs \$15 to \$35. Contact your
local animal shelter to see
which, if any, type of microchip it
scans for. Most Orange County
shelters scan for American Vet-
erinary Identification Devices
(AVID) microchips.

istry lists either the veterinarian
or animal shelter that implanted
the chip, which keeps records of
the animal and its owner; for an
additional fee, the registry keeps
up-to-date information on the
owner's location.

For more information on
microchips, contact your veteri-
narian. Implantation usually
costs \$15 to \$35. Contact your
local animal shelter to see
which, if any, type of microchip it
scans for. Most Orange County
shelters scan for American Vet-
erinary Identification Devices
(AVID) microchips.

nique some hoped would save the
nation's pets from death, said Bill
Brothers, president of Animal
Care Equipment and Services in
Crestline.

"Tattooing is a fantastic idea,
but it basically doesn't work,"
Brothers said. "There should be
just one registry."

With more than 200 tattoo com-
panies, some pets have a registry
number, others the owner's driv-
er's license or Social Security num-
ber.

"The problem with tattooing is,
what does the number mean and
who do you call?" asked Dr. Rich-
ard Glassberg, a Fullerton veteri-
narian who implants AVID micro-
chips.

Some animal-shelter directors
say new technology such as a mi-
crochip inevitably provides some
inconveniences and even a few
wasted dollars. "Remember Beta
...doccassette recorders? The im-

Old-fashioned way

Although new technology of
lets promising means of perma-
nent identification, a pet owner
can never go wrong with the old-
fashioned identification tag at-
tached to a collar around the
pet's neck. For cats, such tags
should be attached to an elastic
safety collar.

A stranger who finds your pet
cannot read a microchip but can
read a tag and call you or return
your lost pet immediately.

Order forms for identifica-
tion tags are available at veterinary
offices and pet stores. The tags
cost about \$5. The tag can in-
clude a friend's or relative's
phone number in case you can't
be reached.

The Animal Assistance
League of Orange County offers
tags. Send a check or money
order for \$4 to Animal Assis-
tance League, Box 38, Midway
City, Calif. 92655. Include your
name and address. An order
form will be mailed.

portant thing, they say, is that even
with multiple systems, hundreds of
lives have been saved.

"If people have to buy a second
chip, so what?" Ventura County's
Jenks said.

"We can't wait to try to save ani-
mals. We need to do something
now," Hamill said.

That's fine as long as buyers
know about the microchip's limita-
tions, Prince said.

"Yes, a microchip can help re-
cover their pet," he said. "But
these ads that say your animal can
be picked up anywhere and identifi-
fied in three seconds? No, that's
not the case."

Microchip becomes new pet tag

Rice-size implants have info to help locate owner

By Anne Sciatar
News staff writer

Most pet owners know the battery of shots that can keep their dog or cat healthy: rabies, distemper, feline leukemia or parvo virus.

But not many know about the newest injection that can save their pet's life.

It's not medicine, but a microchip the size of a grain of rice that can be implanted under the animal's skin. The chip carries an identification number that can be used to locate the pet's owner.

The microchip is read with a hand-held scanner that is passed over the body of the animal. When the chip is located, the screen of the scanner displays a nine-digit number that can be used to search a national data bank and find the pet's home.

"You can't imagine how many times we've had people call and say, 'I was washing my dog and he got away without a collar,'" said Carole Conley, director of development for the Greater Birmingham Humane Society, 1713 Lamb Ave.

Without a collar or tags, animals risk being picked up by Rabies Control, the Birmingham agency that collects strays. Because of space limitations, unidentified animals are kept there for only three to seven days, she said. After that, they are put to sleep.

Ms. Conley said although the non-profit organization has had the scanner for more than a year, the chip has been responsible for only one canine homecoming so far.

"We check every animal that comes through the door, but I think it's because people don't know that this is available," she said.

The injection of the chip costs \$25 and can be performed quickly and painlessly at four veterinarians' offices in the Birmingham area.

AVID, the California company that markets the microchip, charges \$35 to list an owner's

See Microchip, Page 26A



NEWS STAFF PHOTO/EDUARD BRONCHAC

Holly Hill, a veterinarian technician, scans Tess for an indentifying microchip implanted into the dog.

Microchip

From Page 23A

name and address — the registration covers all pets the person owns in his or her lifetime.

The injectable chip has been used for nearly 10 years in laboratory animals and aquariums, said AVID president Dr. Hanns Stoddard, and marine biologists in the Northwest use it to track endangered salmon. The American Kennel Club may soon use the chip in place of the identification tattoo worn by many AKC-registered dogs, and the San Diego zoo has already injected \$20 million worth of animals, an AVID spokesman said.

More than 2.5 million animals carry the microchip, and nearly 500 humane societies across the country have scanners, Stoddard said.

Home wood veterinarian Dr. Charles Becker was the first to bring the microchip system to Birmingham. He donated a scanner — worth about \$1,000 — to the Greater Birmingham Humane Society, and Walker County and Vestavia Hills animal shelters followed suit and purchased scanners.

The chip can help lost pets find their way home, but it can also help settle disputes over ownership, said Humane Society Executive Director Beth Kellogg. "I think it's great because not only do you have a permanent form of ID, but you can prove it's your animal."

Mrs. Kellogg's dog Tess has the microchip implant, along with an AKC tattoo and traditional dog tags. Veterinarians and animal control workers stress that the implant is a supplement but not a replacement for traditional identification tags.

The AVID microchip implant is available in the Birmingham area at Becker Animal Clinic, Vestavia Hills Animal Clinic, Sunlion Animal Clinic and Alford Avenue Veterinary Hospital. For more information, contact the Greater Birmingham Humane Society at 780-7281.

Identification implant chip can help rescue lost pets

Weak in and weak out, I tell you about products that are, or soon will be, vying for a chunk of our psyches.



GADGET GURU

ANDY PAROCH

I don't know the service exists. I'm talking about the AVID microchip and PETtrac. These work together to provide a permanent identification system for pets. Here's how it works:

PETtrac is a national computer network designed to expedite the return of lost or stolen pets. It uses the AVID microchip — a tiny integrated circuit slightly larger than a grain of rice that is implanted under a dog or cat's skin at the base of the neck.

Chip identifies pet

The module is encoded with an identification number that can be cross-referenced to the pet's owner or veterinarian. Unlike a tag or collar-secured name plate, it cannot fall off.

If the pet gets lost and ends up in an animal control center, the attendant can pass a scanner over the pet's shoulder. If the pet has a PETtrac implant, its identification number will appear on the scanner's digital display. The folks at the animal control center can call a toll-free number and learn the owner's and/or veterinarian's name and number.

You may not think this is a big deal. But when you consider that one out of every three family pets will be lost, and only about 10



FLEA FIGHTERS: White pet is brushed, flea shampoo or dip is evenly dispersed through tiny holes in the thick bristles.

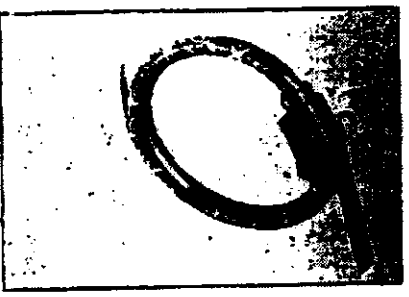

COLLAR OF LIGHT:

Battery-operated color features a series of flashing red lights.

percent of lost pets are ever reunited with their owners, this plan makes a lot of sense.

The cost is reasonable, too. A one-time charge of about \$50 includes the cost of the electronic module and inclusion in the PETtrac national register. If the family moves, a change of address can be made at no charge.

Donated to shelters

What really makes this pro-

gram good is that scanners are donated, at no cost, to animal shelters. There is one catch: The shelter has to promise, in writing to the manufacturer, that its staff will scan each pet upon arrival, or at least prior to euthanasia, placement or sale, and promptly notify the owner. The scanning process takes less than 10 seconds.

The system does work. A test program on an Air Force base in Misawa, Japan, achieved phenomenal success in its first year. The year before the program was begun, 180 animals were euthanized. During the program's first year, that number was reduced to 15.

For the names of veterinarians who can implant the AVID microchip in your pet, call (800) 336-AVID from 10:30 a.m. to 9 p.m. or write to AVID, 3179 Hammer, Suite 5, Norco, Calif. 91760

Illuminated collar

A novel way to ensure your pet's safety is with the Protect-a-Pet. This is an illuminated collar that makes your pet visible at night.

The Protect-a-Pet is a clear plastic collar that features a series of enclosed red lights that flash sequentially. It runs on three button-type batteries, has



HIGH-TECH ID: Scanner shows the ID number implanted in a module in dog's shoulder.

an on/off switch, is available in five sizes and sells for \$20.

For information, call Hammer-Schickner at (800) 543-3366 from 7 a.m. to midnight daily; ask for item No. 46322H.

Summertime is flea and tick season, and most pet owners know that applying sprays or powders to a dog can be more difficult than it sounds. That is, unless you have the Brush-Ere.

Inside this thick-orsted plastic brush is a reservoir for flea shampoos or dips. While brushing, the shampoo evenly disperses through tiny holes in the bristles. It sells for \$10 at pet stores.

Have a question? Write: Gadget Guru, 95 White Bridge Rd., Suite 503, Nashville, Tenn. 37205. Fax number: (615) 356-9596.

T H E O R A N G E C O U N T Y
Register

MARCH 7, 1993

Sunday, March 7, 1993 The Orange County Register 35

**The ramifications of
 microchip pet implants**



Often things begun with the best intentions are easily transformed into procedures that are less than desirable ["Microchip implants aren't the perfect pet ID," news, Jan. 8].

Implanting microchips in our animals sounds reasonable enough. We own our pets. If they are

lost, we have a better chance of finding them if they are picked up by animal shelters that are equipped with scanners.

However, it seems to me that we are in the beginning stages of a larger experiment. Suppose these chips could be enhanced to emit radio waves that are readable at greater distances? We would then have a tracking device. Suppose we implanted microchips in our littlest children in case they are lost or stolen. We already have programs to fingerprint them, why not implant them? But in the process of protecting them, aren't we, in effect, declaring ownership of them? At what age would we declare that person sovereign? Perhaps it would be decided to leave the chips in place to aid in census taking or some other benign purpose.

We could conceivably have the beginnings of a whole society of people registered by some agency and traceable anywhere in the world. Perhaps we could find dead-beat fathers, perhaps we could all be monitored for our movements and associations.

Suppose those chips were further enhanced to receive? What kind of messages might be programmed into an individual? And from whom? This may sound like paranoia or science fiction, but the technology isn't that far away. Implanting sounds like a good idea when we're talking about dogs. What will we say when it's suggested for humans?

Linda Stearns
 Justin



- Proven technology
- Solid customer base
- Experienced management
- Exciting growth potential
- Low-cost manufacturing capability

DESTRON/IDI



How Dual-Coil Technology Works

In traditional passive radio frequency identification systems, a transponder passing within range of a reader is powered by the excitation signal emitted by the coil in the reader. The same coil then picks up the low-power signal returned by the transponder. With Destron/IDi's new advanced dual-coil technology, two different coils are used, one for sending the excitation signal and a second one for picking up the transponder's return signal. This allows the second coil to be tuned specifically to the return signal frequency. The result is greater receiver sensitivity and improved read range.

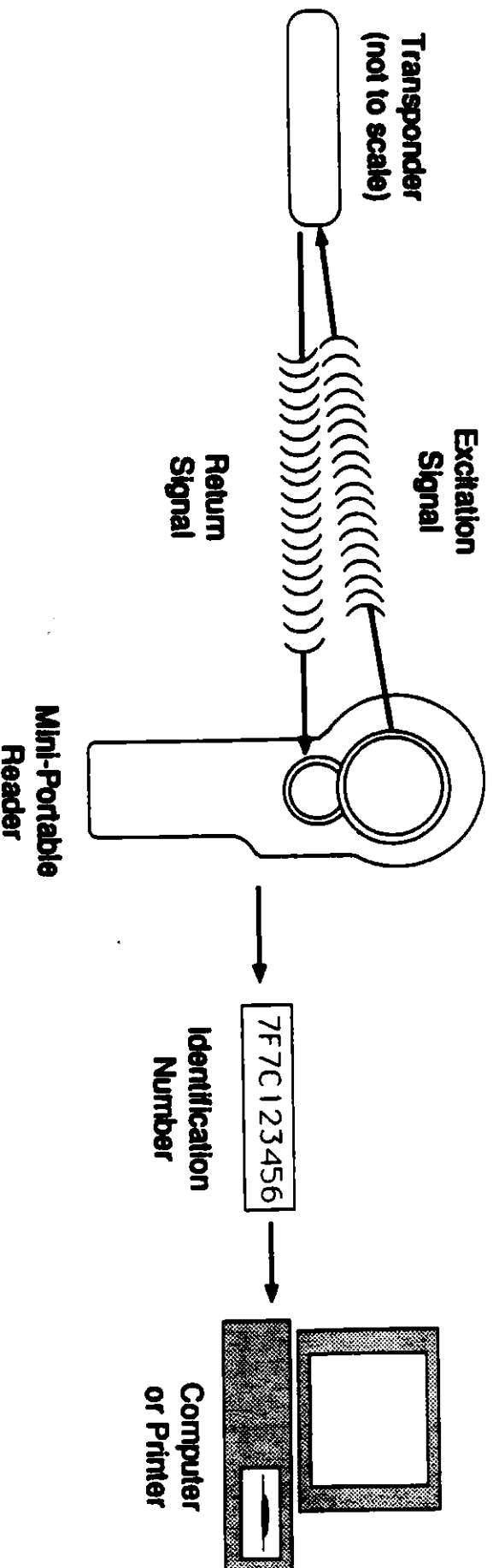

Most people are familiar with the laser scanning of bar codes in supermarkets to identify goods at the check-out line, and bar codes used by the postal service to automatically identify packages and letters. Destron/IDI's electronic identification system provides essentially the same capability for the identification of animals, where an ID system using labels is not practical.

There are two basic differences between electronic identification and bar code technology: how the ID number is read and how it is stored. Electronic identification uses a common low-power radio signal to read an ID number stored in a tiny electronic circuit rather than laser light to read a label. Electronic ID based on these radio signals is also referred to as radio frequency identification, or RFID. These low-frequency radio waves, unlike light, can penetrate all solid objects except those made of metal. Therefore, use of electronic ID allows the number to be stored inside the animal, where it is permanent and is not subject to being lost or altered, or becoming worn and unreadable like an external dog tag.

The tiny electronic device used to store the electronic ID number is called a transponder. Destron/IDI's transponders come in three sizes (see Figure 1), the smallest of which is about the size of an uncooked grain of rice. All of the transponders are easily injected into an animal, similar to the delivery of ordinary vaccines. The device then remains with the animal for life, where it provides the animal's unique ID number any time it is scanned by a compatible electronic ID reading system. Most Destron/IDI reading systems, or scanners, send a signal using a frequency of 125 kHz, much lower than the frequencies used in AM medium-wave broadcasting. The power of the radio signal sent by the scanner is less than one one-thousandth of a watt (one milliwatt), which

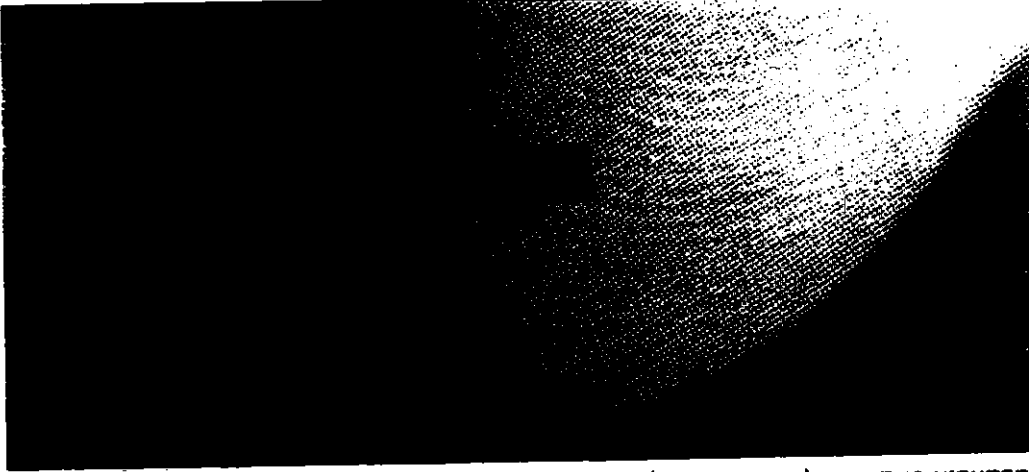
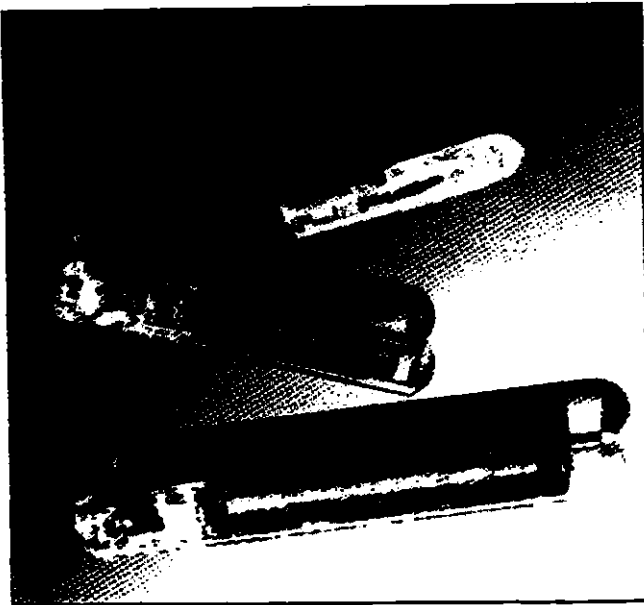

Figure 2. Microchip on human finger

Destron/IDI's transponders are passive devices, meaning that the transponder carries no battery and remains inactive most of the time. The transponder's tiny electronic circuit is energized by the low-power radio beam sent by a compatible reading device. The transponder sends the ID number as a radio signal back to the scanner, which then decodes the number and displays it on a small screen similar to that on an electronic calculator. Since the transponder contains no battery there is nothing to wear out.

is far less than the power transmitted by a child's two-way radio (walkie-talkie). Destron/IDI scanners are approved by the FCC in the U.S. and by similar organizations in other countries (PTTs) to operate as low-power radio-frequency devices not requiring site licensing.

Figure 1. Destron/IDI transponders



Therefore, small transponders are available with one end sheathed in a polypropylene shell as shown in Figure 4. This coating offers a surface with which fibrous connective tissue begins to bond within 24 hours of the injection. Destron recommends this configuration of the transponder whenever migration is a concern or with subcutaneous (under-the-skin) injections, such as those done in dogs and cats.

In dogs and cats, the transponder is injected in a standard site which is in the scruff of the neck between the shoulder blades (scapula). In horses, the standard injection site is on the left side of the animal in the middle third of the neck, just below the long hairs of the mane. For these injections, each transponder comes pre-packed inside a needle, and this assembly is packaged in a pre-sterilized plastic envelope. Each needle is discarded after one-time use. This prevents the spread of infection, and insures that the needle is factory sharp so as to cause minimum discomfort to the animal.

Numerous studies have been performed on a wide variety of animal species to demonstrate the safety of the transponder. These studies have involved mammals, birds, fish, and reptiles which have shown no adverse reactions to the transponder, either biological or behavioral. Many of these studies have been documented in published papers.

While Destron pioneered injectable transponders for animals in 1985, electronic identification technology in general was already well established before that time. Applications included external electronic ID for animals (ear tags, electronic collars, etc.), identification of people for access to buildings or restricted areas and identification of manufactured goods, machine tools, and other items in a factory environment.

The transponders are cylindrical, with the smallest measuring 11 mm in length and 2.1 mm in diameter. Inside are only three components. The first is a computer microchip (custom integrated circuit) which is shown in Figure 2 on a human finger. This microchip contains the unique ID number assigned to the transponder, and all of the electronic circuitry necessary to send the number to the scanner when it receives the scanner radio signal.

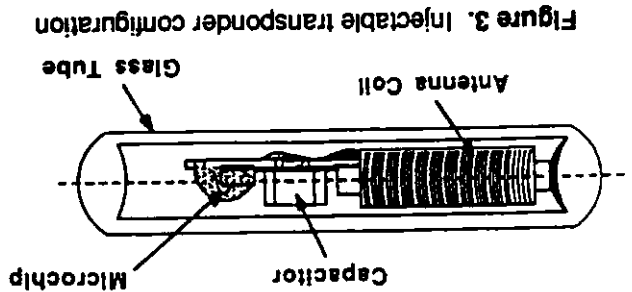

Figure 3. Injectable transponder configuration

The second component of the transponder is a coil of copper wire wound around a ferrite (iron) core. This functions as a tiny radio antenna to pick up the signal from the scanner, and to send the encoded ID number from the microchip back to the scanner. The third component is a capacitor used for tuning. The internal structure of the transponder is shown in Figure 3.

Each transponder's unique ID number is encoded into it during the manufacturing process. A laser etches this code onto the surface of the microchip prior to transponder assembly and encapsulation in glass. Once the number is encoded it is impossible to alter. Encoding the number itself uses 35 bits of information which allows 34 billion possible ID numbers.

The outside of the transponder is a soda lime glass which has been specially selected for known biocompatibility. During manufacture, this glass is hermetically sealed so it is not possible for any moisture from the host animal's body fluids to reach the electronics inside. While glass is biochemically inert it is also very smooth, which, in rare instances could allow the transponder to move around in the animal's body once injected.



Figure 4. Photomicrograph of transponder with anti-migration tip

Injection System Model AY0014

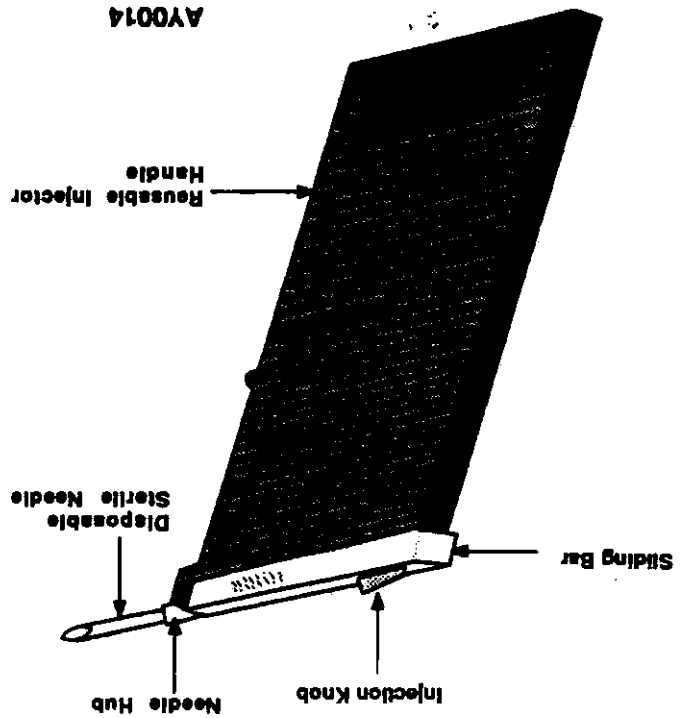

Features

- ▶ Proven technology has been in use for five years, with over a half million small animals injected.
- ▶ Light-weight, pistol-grip style allows easy control of needle insertion.
- ▶ Pre-packaged sterile needle including small injectable transponder eliminates the need for manual sterilization.
- ▶ Sterility is maintained because injector push-rod does not directly contact sterile transponder.
- ▶ Small injectable transponder comes with a proven, patented anti-migration tip.
- ▶ Reusable injection handle is made from durable, easy-to-clean material.
- ▶ Injection handle is designed for both right-handed and left-handed users.
- ▶ Provides positive, permanent identification for the life of the animal.
- ▶ Transponder assembly supplied sterile with barcode printout of the unique number. One assembly per sterile pouch.

Description

The Lifechip™ Transponder Injection System consists of a reusable injector handle and a sterile needle assembly which contains a small injectable transponder. The system is designed to maximize convenience and ease of use while minimizing discomfort at the injection site. Injecting a small transponder with the Lifechip system ensures that the animal can be identified electronically with its own unique, ten-digit alphanumeric code. The code is programmed into the injectable transponder, which is packaged as part of the sterile needle assembly. The identification code is easily read with a compatible reader manufactured by Destron/ID.

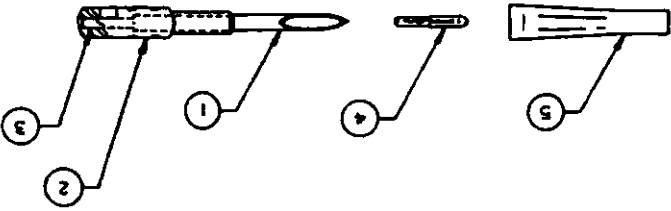

TX1412L - Transponder Assembly

Specifications

- 1. Stainless steel needle
 - 2. Polypropylene needle guide
 - 3. Polypropylene drive pin
 - 4. Lithchip transponder with anti-migration tip
 - 5. Protective plastic sheath
 - 6. Not shown - sterile pouch and barcode label
- Needle assembly dimensions: 1.86" by .288" (47.34 mm by 7.32mm)
 Transponder dimensions: 0.43" by 0.08" (11 mm by 2.1 mm)
 Injector needle size: Approximately 12-gauge
 Needle assembly temperature: -40° to 158° F (-40° to 70° C) operating and storage
 Transponder housing: Bio-compatible glass with a polypropylene anti-migration cap.
 Transponder operating frequency: 125kHz

**Handi Reader
Model HS5600L1**



Display: 16-character LCD
0.20" (0.52 cm) character height

Batteries: Two 9-volt alkaline
(500 minimum readings)

Operating ranges: Temperature 32° to 122° F (0° to 50° C)
Humidity 10% to 90% (noncondensing)
Shock 20 g

Dimensions: 10.25" x 5.00" x 5.50"
(26.04 cm x 12.70 cm x 13.97 cm)

Weight: 1.43 lbs (0.65 kg)

Operating frequencies: Scanner exciter 125 kHz
Transponder response 12.5 kHz and 15.63 kHz

Read speed: 120 msec maximum

Features:

- **Low Cost.** The Handi Reader is the most economical reader on the market.

- **Easy to Use.** The push of a button turns the power on and begins the scanning function.

- **Portable.** The entire one-piece unit weighs just over one pound (0.65 kg) and is easily carried and operated with one hand.

- **Replaceable Batteries.** You'll never need to wait for the Handi Reader to recharge - it uses two standard 9-volt batteries that are easy to replace.

- **Durable.** A tough, water-resistant outer shell makes the Handi Reader perfect for indoor or outdoor use.

- **Automatic Shutdown.** The Handi Reader automatically shuts down when left unused for one minute, prolonging battery life.

Product Description:

The Destrón/IDI Handi Reader is a compact, one-piece device that reads identification numbers from compatible radio frequency identification (RFID) tags. Destrón/IDI's RFID tags are injectable transponders used for the identification of dogs, cats, birds, horses and other companion animals.

The Handi Reader energizes passive transponders with an excitation signal of 125 kHz, decodes the return signal and displays the identification number on a 16-character liquid-crystal display window. To ensure efficient operation, the reader also emits a beep and flashes a red LED to signal that a compatible transponder has been detected.

The microprocessor-based Handi Reader incorporates advanced surface-mount components and is powered by standard, replaceable 9-volt batteries.

Specifications:

Typical read distances:
small 3.00" (7.62 cm)
medium 4.50" (11.43 cm)
large 6.00" (15.24 cm)
(in a benign noise environment with optimal orientation of transponder to reader at 77° F (25° C))



Specifications:

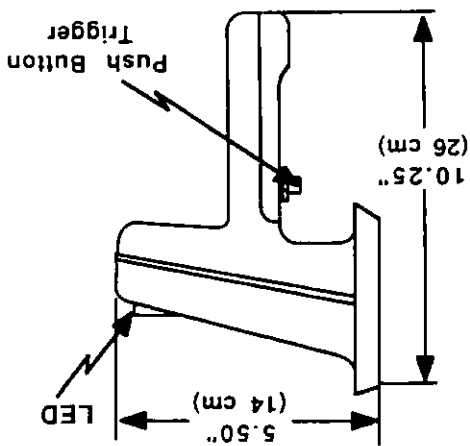
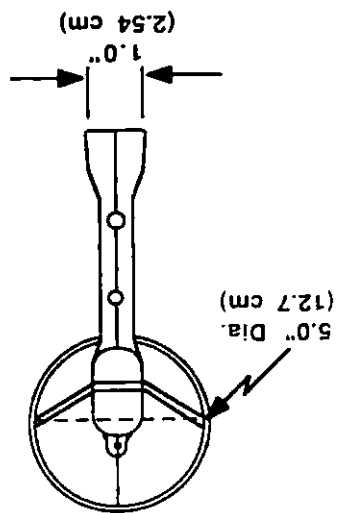

How to order:

Order the Handi Reader Model HS5600L1 from your Destron/DI distributor. The Handi Reader comes with two 9-volt batteries, a transponder test piece, and a complete set of operating instructions.

For more information or to comment on lifechip products manufactured by Destron/DI, contact your local distributor listed below:

Warranty:

Destron/DI products are warranted against defects in materials and workmanship, under normal use and service, for one (1) year from the date of shipment. This warranty will not apply if adjustment, repair, or parts replacement is required because of accident; neglect; misuse of electric power, air conditioners, or humidity control; damage during transportation; or causes other than ordinary use. This warranty is void if seals to the electronic components are not intact. Destron/DI's sole responsibility under this warranty shall be, at its option, to either repair or replace any product which fails during the warranty period.

This device involves technology covered by U S Patents #4,730,188, 5,041,826 and 5,166,676. Other patents pending.

Specifications subject to change without notice.

© 1992, Destron/DI Inc



DESTRON/IDI

Injectable Transponder TX1400L Small Size

Product Description:

The injectable Transponder is a passive radio-frequency identification tag, designed to work in conjunction with a compatible radio-frequency ID reading system. The transponder consists of an electromagnetic coil, tuning capacitor, and microchip sealed in a cylindrical glass enclosure. The chip is pre-programmed with a unique ID code that cannot be altered; over 34 billion individual code numbers are available. When the transponder is activated by a low-frequency radio signal, it transmits the ID code to the reading system.

Although specifically designed for injecting in animals, this transponder can be used for other applications requiring a micro-sized identification tag.

Specifications:

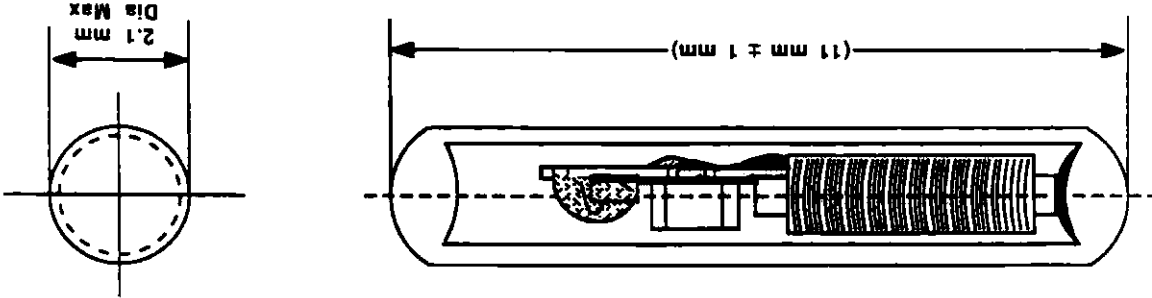

Dimensions (nominal): 11 mm by 2.1 mm (0.43" by 0.08")

Housing: Bio-compatible glass

Average weight: 0.06 g (0.002 ounces).

Temperature range: -40 to 70°C (-40 to 158°F), operating and storage

Read range with the HS5105L Mini-Portable Reader:

(In a benign noise environment with optimal orientation of transponder and scanner)
Maximum: 10 cm (4")

Read speed: Approximately 1 meter per second

Vibration:

Sinusoidal: 1.5 mm (0.06") peak-to-peak, 10 to 80 Hz, 3 axis
Sinusoidal: 10 g peak-to-peak, 80 Hz to 2 kHz, 3 axis

Injector needle size: About 12 gauge

Operating frequency: 125 kHz



Injectable Transponder TX1410L2 Medium Size

Product Description:

The Injectable Transponder is a passive radio-frequency identification tag, designed to work in conjunction with a compatible radio-frequency ID reading system. The transponder consists of an electromagnetic coil, tuning capacitor, and microchip sealed in a cylindrical glass enclosure. The chip is pre-programmed with a unique ID code that cannot be altered; over 34 billion individual code numbers are available. When the transponder is activated by a low-frequency radio signal, it transmits the ID code to the reading system.

Although specifically designed for injecting in livestock, this transponder can be used for other animal and nonanimal applications.

Specifications:

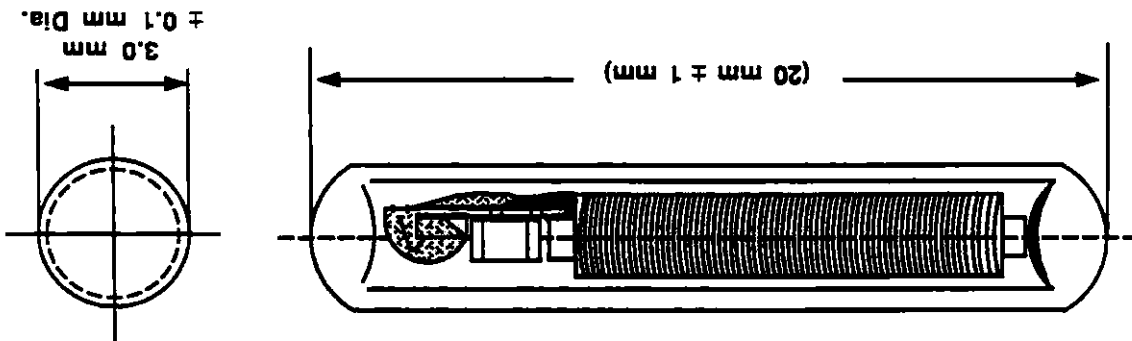

Dimensions (nominal): 20 mm by 3.0 mm (0.78" by 0.11")

Housing: Bio-compatible glass

Average weight: 0.23 g (0.008 ounces).

Temperature range: -40 to 70°C (-40 to 158°F), operating and storage

Read range with the Model HSS105L2 Mini-Portable Reader:

(in a benign noise environment with optimal orientation of transponder and scanner)

HSS105L2	Typical	22.9 cm (9")
	Minimum	20.3 cm (8")

Read speed: 3 meters per second

Vibration:

Sinusoidal: 1.5 mm (0.06") peak-to-peak, 10 to 80 Hz, 3 axis
Sinusoidal: 10 g peak-to-peak, 80 Hz to 2 kHz, 3 axis

Injector needle size: About 8 gauge (Destron part # 445-0012-00)

Operating frequency: 125 kHz